

EXPO PROFESSIONAL

'24 Collection

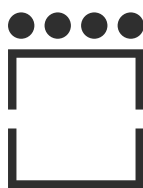

DELLA MARTA
ITALY



DELLA MARTA

Collezione Expo Professional

Ricerca ed innovativa, la collezione di vetrine climatizzate Expo Professional rappresenta quanto di più rivoluzionario sia mai stato ideato nel seducente mondo degli appassionati di vino. Sono oggetti dal concept e design inconfondibile, trasformati negli anni in veri e propri simboli e destinati a diventare preziose icone senza tempo.

La collezione Professional è stata disegnata da Massimo Della Marta, designer e grande appassionato di vino.

Per la prima volta, le cantine climatizzate, oltre che funzionali strumenti di conservazione e servizio del vino, sono raffinati complementi di arredo che consentono una elegante ed ordinata esposizione dei vini.

Brevetti mondiali come, la Teca, il Quadro Vino e l'impianto di refrigerazione centrale, hanno confermato il valore del know-how del brand nell'ambito del wine design e della tecnologia termodinamica applicata alla conservazione del vino.

L'eccellente qualità che l'azienda propone da sempre è ottenuta applicando un sistema di produzione che prevede congiuntamente processi produttivi industriali e lavorazioni artigianali. Ogni prodotto viene costruito da tecnici specializzati utilizzando materie prime e semilavorati di altissima qualità e ponendo particolare cura per ogni dettaglio.

La collezione Expo Professional è realizzata interamente in Italia, negli stabilimenti Della Marta alle porte di Torino. Scelti dai più grandi Sommelier e Chef a livello internazionale, arredano con eleganza i migliori ristoranti ed hotel in tutto il mondo.

Sophisticated and ground-breaking, Expo's professional climate wine cabinet collection is a revolution in the enticing world of wine enthusiasts. Unique by concept and design, through the years they have become a symbol destined to become timeless, precious icons.

The professional collection is designed by Massimo Della Marta, designer and wine enthusiast.

For the first time, climate wine cellars, from functional home appliances, become sophisticated pieces of furniture to display wine cleanly and gracefully.

World patents such as Quadro Vino, Teca, and the central refrigeration system, have confirmed the value of the brand's know-how in wine design and thermodynamics applied to wine conservation.

The company's everlasting commitment to excellence in quality is achieved through a production system that combines industrial production processes and craftsmanship. Each product is made by specialised technicians, employing prime materials and semi-finished products of the highest quality, with painstaking attention to detail.

The Expo Professional collection is entirely made in Italy, at the Della Marta premises just outside Turin.

Chosen by the greatest international Sommeliers and Chefs, they elegantly trim the fanciest hotels and restaurants of the world.

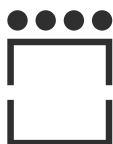

Index

Collezione Expo Professional

Teca

Teca	Pag.	4
------	------	---

Mod

Mod A	Pag.	28
Mod B	Pag.	42
Mod D	Pag.	46

Emme 12

Emme 12	Pag.	56
---------	------	----

Quadro Vino

Quadro Vino n. 12	Pag.	66
Quadro Vino n. 30	Pag.	68
Quadro Vino n. 40	Pag.	70
Quadro Vino n. 52	Pag.	72

Area tecnica

Technical area	Pag.	74
Optional	Pag.	126

Cartella colori

Colour chart	Pag.	144
--------------	------	-----

Legenda

Legend	Pag.	146
--------	------	-----



Teca



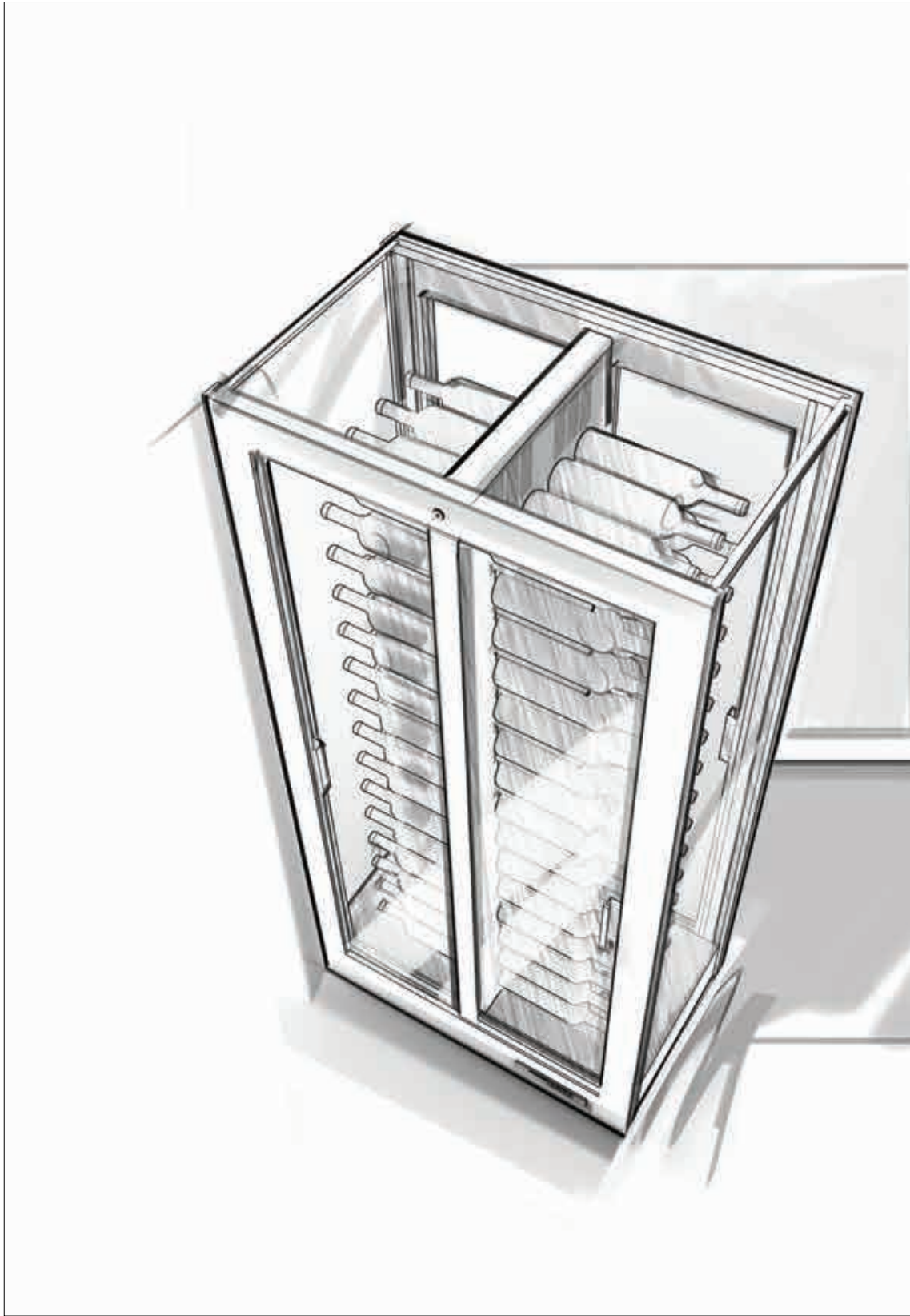

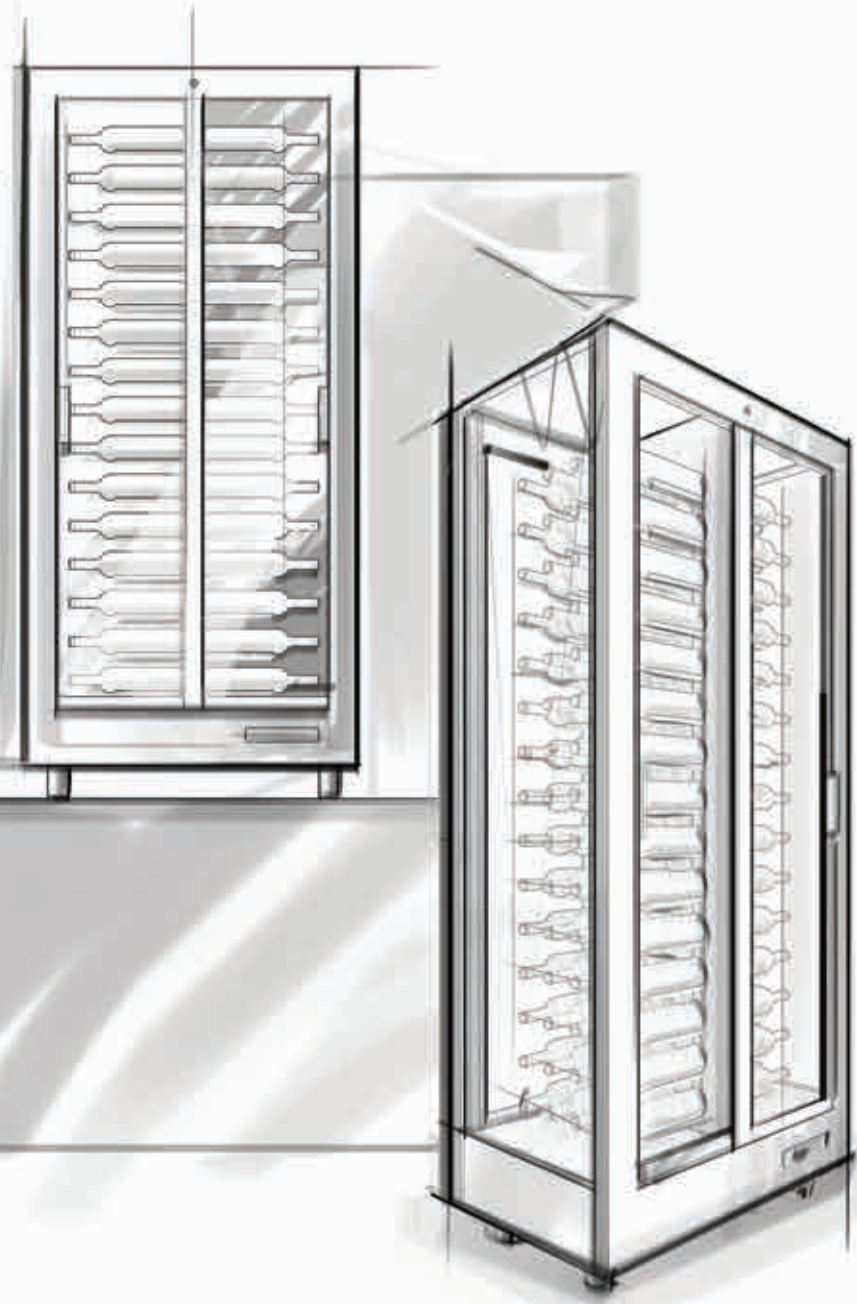

Q



Teca

La Teca si presenta sobria ma elegante, volutamente minimalista ed essenziale. Le bottiglie sono parte della scenografia dove la particolare esposizione in orizzontale ne esalta valore e bellezza. È un oggetto dal design inconfondibile destinato a rendere speciale ogni ambiente in cui è inserito.

Teca is sober but elegant, deliberately minimal and essential. The bottles are part of a scene where the trademark horizontal display enhances value and beauty. It is an object with a unique design intended to give a unique feel to any location.







 +5 / +18

Free standing

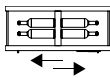
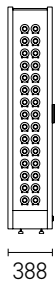
Built in

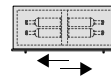

TV-H10



TBV-H10

388

874 x 388 x 1865

60

388

874 x 388 x 1865

60

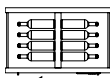
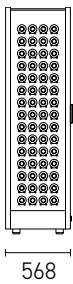

TV-M10

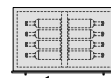

TBV-M10

568

874 x 568 x 1865

120

557

874 x 557 x 1865

120

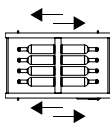
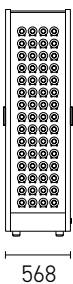

TV-C10

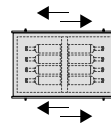

TBV-C10

568

874 x 568 x 1865

120

568

874 x 568 x 1865

120

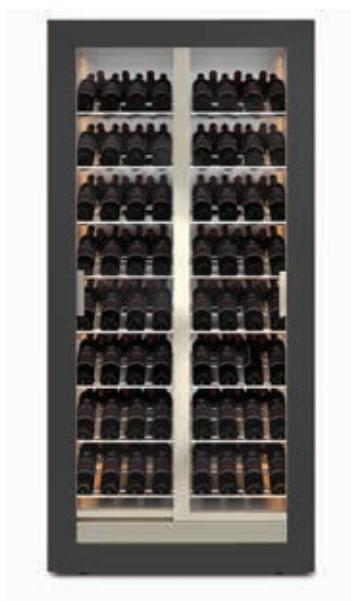

°C
+5 / +18

Free standing

Built in

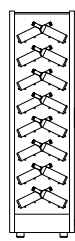

568

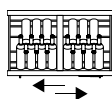

mm
874 x 568 x 1865

TV-M12



112

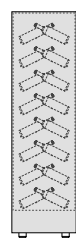

557

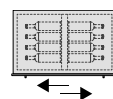

mm
874 x 557 x 1865

TBV-M12



112

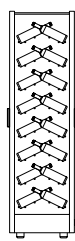

568

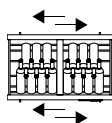

mm
874 x 568 x 1865

TV-C12



112

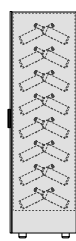

568

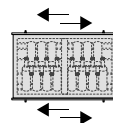

mm
874 x 568 x 1865

TBV-C12





112



Teca

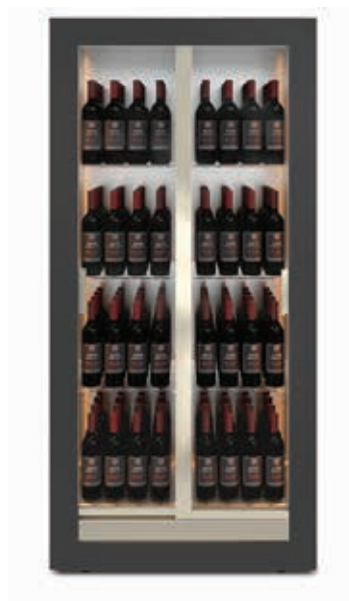



 °C
 +5 / +18

Free standing

Built in

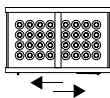

TV-M13

568

874 x 568 x 1865

128

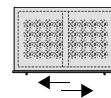
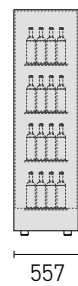

TBV-M13

557

874 x 557 x 1865

128

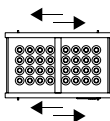

TV-C13

568

874 x 568 x 1865

128

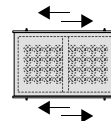
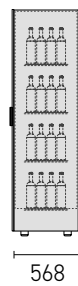

TBV-C13

568

874 x 568 x 1865

128

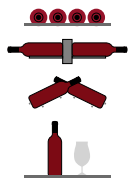

Allestimento interno personalizzabile
Custom internal layout



°C
+5 / +18

Free standing

Built in



388

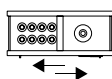

mm
874 x 388 x 1865

TV-H14



56 / 64



388

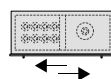

mm
874 x 388 x 1865

TBV-H14



56 / 64

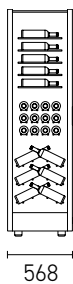

568

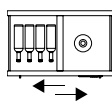

mm
874 x 568 x 1865

TV-M14



112 / 128



557

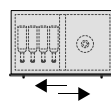

mm
874 x 557 x 1865

TBV-M14



112 / 128

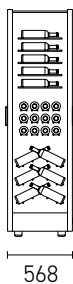

568

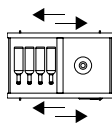

mm
874 x 568 x 1865

TV-C14



112 / 128

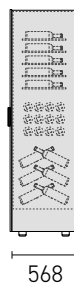

568

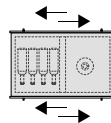

mm
874 x 568 x 1865

TBV-C14



112 / 128



Teca



SALUMERIA

Salami



°C
+5 / +18

Free standing

Built in

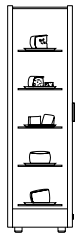

568

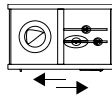

TS-M10

mm

874 x 568 x 1865



557

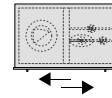

TBS-M10

mm

874 x 557 x 1865



568

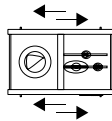

TS-C10

mm

874 x 568 x 1865



568

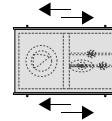

TBS-C10

mm

874 x 568 x 1865

GASTRONOMIA

Delicatessen



 °C
 +5 / +18

Free standing

Built in



388

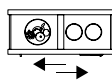

mm

874 x 388 x 1865

TG-H10



388



mm

874 x 388 x 1865

TBG-H10

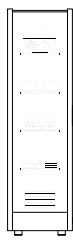

568

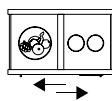

mm

874 x 568 x 1865

TG-M10



557

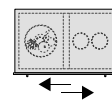

mm

874 x 557 x 1865

TBG-M10



568

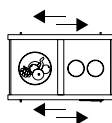

mm

874 x 568 x 1865

TG-C10



568

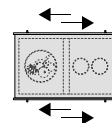

mm

874 x 568 x 1865

TBG-C10



Teca

CIOCCOLATO

Chocolate

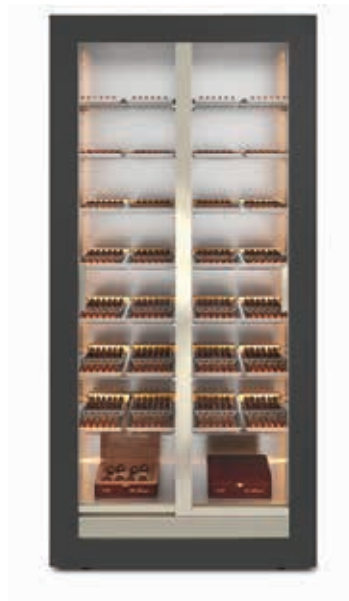

+14 / +16

Free standing

Built in



388

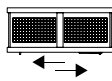

mm

874 x 388 x 1865

TC-H10



388

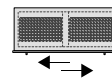

mm

874 x 388 x 1865

TBC-H10



568

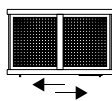

mm

874 x 568 x 1865

TC-M10



557

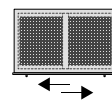

mm

874 x 557 x 1865

TBC-M10



568

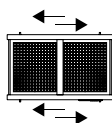

mm

874 x 568 x 1865

TC-C10



568

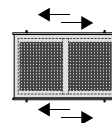

mm

874 x 568 x 1865

TBC-C10



Teca





 °C
 +5 / +18

TV-H20

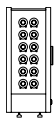

388



mm

874 x 388 x 910



24

TV-M20

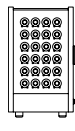

568

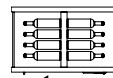

mm

874 x 568 x 910



48

TV-C20

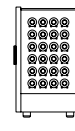

568

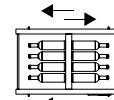

mm

874 x 568 x 910



48



 °C
 +5 / +18

TV-M22

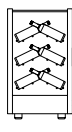

568

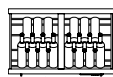

mm

874 x 568 x 910



42

TV-C22

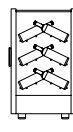

568

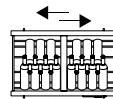

mm

874 x 568 x 910



42



 °C
 +5 / +18

TV-M23

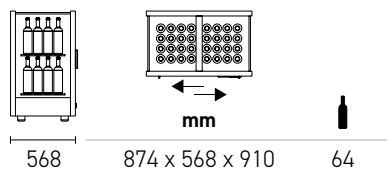

TV-C23

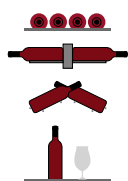
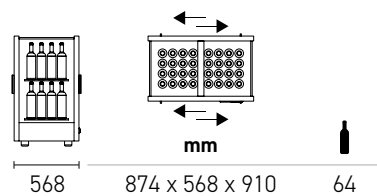

Allestimento interno personalizzabile
Custom internal layout



 °C
 +5 / +18

TV-H24

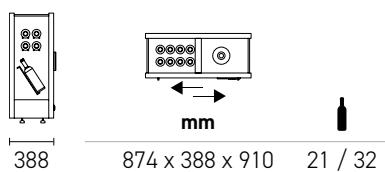

TV-M24

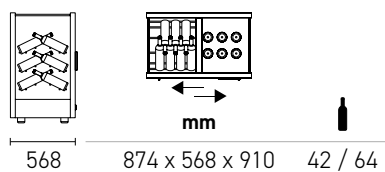

TV-C24

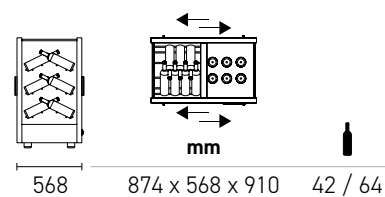

SALUMERIA

Salami



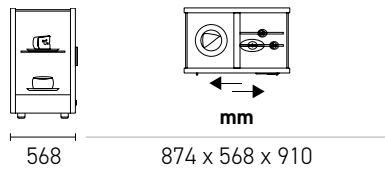

 +5 / +18

TS-M20

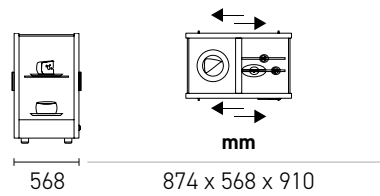

TS-C20



GASTRONOMIA

Delicatessen



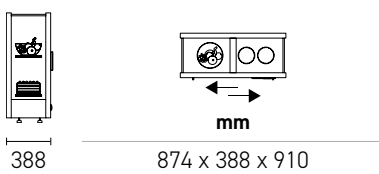

 +5 / +18

TG-H20

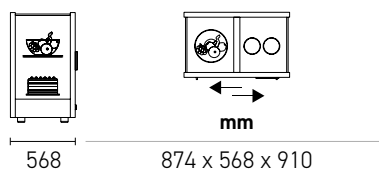

TG-M20



TG-C20

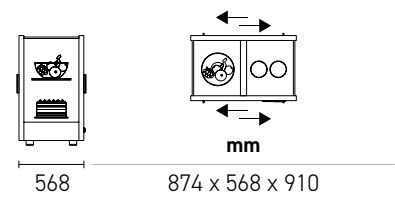

CIOCCOLATO

Chocolate



 °C
 +14 / +16

TC-H20



388

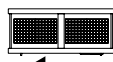

mm

874 x 388 x 910

TC-M20

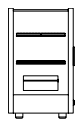

568

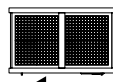

mm

874 x 568 x 910

TC-C20



568

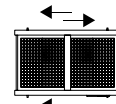

mm

874 x 568 x 910

OPT-V1

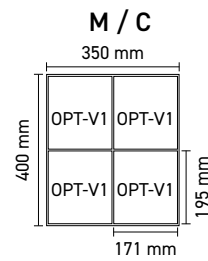
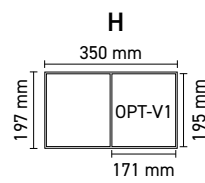



Mod



Sistema modulare per l'esposizione, conservazione e servizio del vino. L'inserimento di uno o più moduli gastronomia, salumeria o cioccolato consente di realizzare una pratica, elegante e ben distinta area dedicata esclusivamente all'esposizione enogastronomica.

Modular system for displaying, storing and serving your wine. Adding one or more cold dishes, cured meats/cheese, or chocolate modules makes for a practical, elegant, and remarkable area for your wine and food display.



363

PH-VAR10

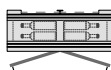

mm

900 x 363 x 1858



60



515

PM-VAR10

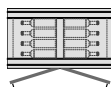

mm

900 x 515 x 1858



120



520

PC-VAR10

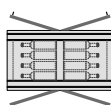

mm

900 x 520 x 1858



120



515

PM-VAR12

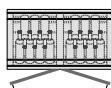

mm

900 x 515 x 1858



112

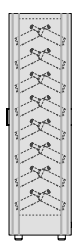

520

PC-VAR12

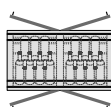

mm

900 x 520 x 1858



112

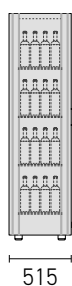

PM-VAR13

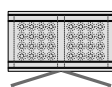

mm

900 x 515 x 1858



128

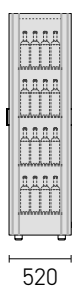

PC-VAR13

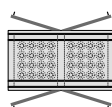

mm

900 x 520 x 1858



128

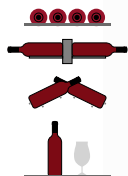

Allestimento interno personalizzabile
Custom internal layout



°C
+4 / +18



363

PH-VAR14

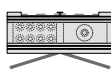

mm

900 x 363 x 1858



56/64



515

PM-VAR14

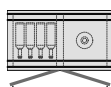

mm

900 x 515 x 1858



112/128



520

PC-VAR14

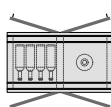

mm

900 x 520 x 1858



112/128





MODULI SALUMERIA

Salami modules



515

PM-SAR10

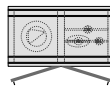

mm

900 x 515 x 1858



520

PC-SAR10

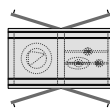

mm

900 x 520 x 1858

MODULI GASTRONOMIA

Delicatessen modules

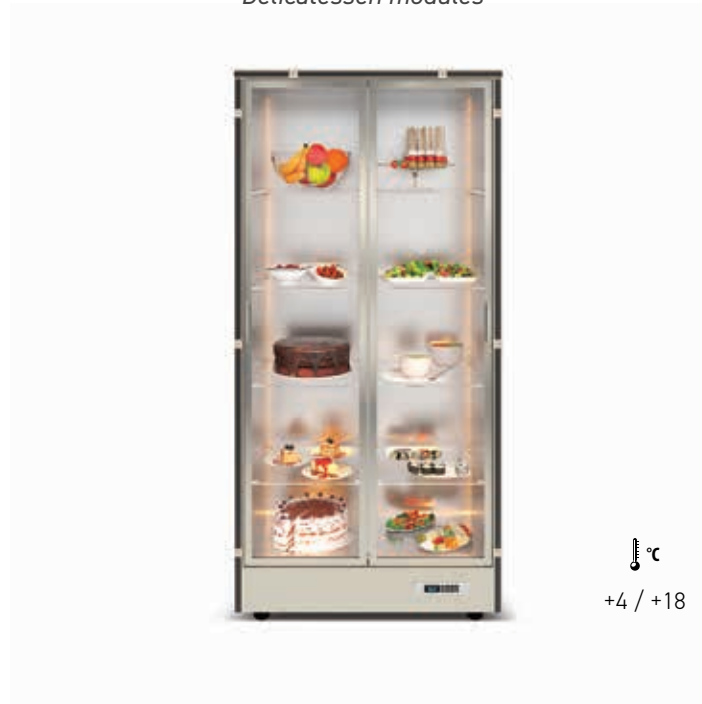

363

PH-GAR10

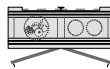

mm

900 x 363 x 1858



515

PM-GAR10

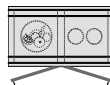

mm

900 x 515 x 1858



520

PC-GAR10

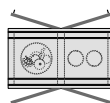

mm

900 x 520 x 1858

MODULI CIOCCOLATO

Chocolate modules

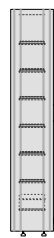

363

PH-CAR10

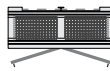

mm

900 x 363 x 1858



515

PM-CAR10

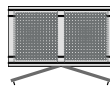

mm

900 x 515 x 1858



520

PC-CAR10

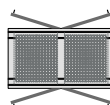

mm

900 x 520 x 1858

MODULI NEUTRI

Neutral modules

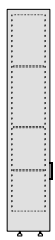

355

PH-MA10

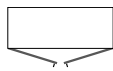

mm

900 x 355 x 1858

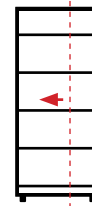

Modulo realizzabile su misura da cm 20 a cm 90
Custom made unit from cm. 20 up to cm. 90

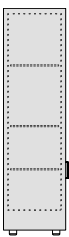

515

PM-MA10

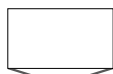

mm

900 x 515 x 1858

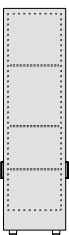

520

PC-MA10

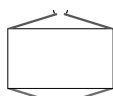

mm

900 x 520 x 1858

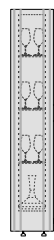

363

PH-MA30

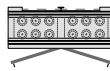

mm

900 x 363 x 1858

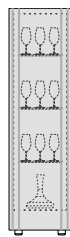

515

PM-MA30

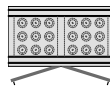

mm

900 x 515 x 1858



520

PC-MA30

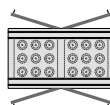

mm

900 x 520 x 1858



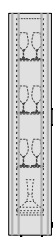

363

PH-MA40



mm

486 x 363 x 1858

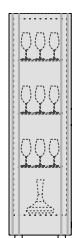

515

PM-MA40



mm

486 x 515 x 1858



520

PC-MA40



mm

486 x 520 x 1858





Modulo "B"

MODULI REFRIGERATI PER VINO - B

Wine cooling units

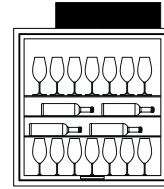

• Vista posteriore
Rear view

PC-VBR10

°C
+14 / +16

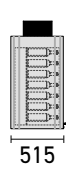

64

PM-VBR10

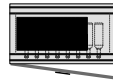

515

mm 900 x 515 x 1050

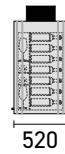

64 + •

PC-VBR10



520

mm 900 x 520 x 1050

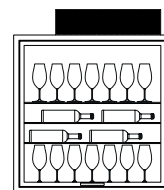

• Vista posteriore
Rear view

PC-VBR13

°C
+14 / +16

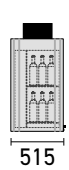

80

PM-VBR13

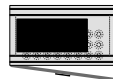

515

mm 900 x 515 x 1050

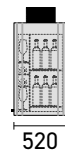

80 + •

PC-VBR13



520

mm 900 x 520 x 1050

MODULI NEUTRI - B

Neutral modules



PH-MB30

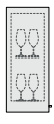

363

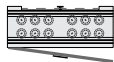

mm

900 x 363 x 900



PM-MB30

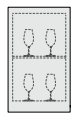

515

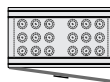

mm

900 x 515 x 900



PC-MB30

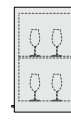

520

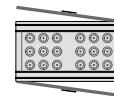

mm

900 x 520 x 900



PH-MB40

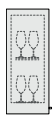

363



mm

486 x 363 x 900



PM-MB40



515



mm

486 x 515 x 900



PC-MB40

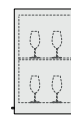

520



mm

486 x 520 x 900





PH-MB20

PM-MB20

PC-MB20

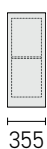

mm
900 x 355 x 900



mm
900 x 520 x 900

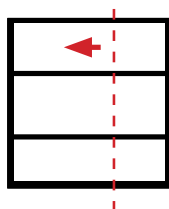

Modulo realizzabile su misura da cm 20 a cm 90
Custom made unit from cm. 20 up to cm. 90



Modulo "D"



Con l'utilizzo del modulo "D" è possibile realizzare sia una soluzione tipo banco, utilizzando il rivestimento FIT, sia la soluzione a pensile, utilizzando le cornici.

Per realizzare una elegante esposizione enogastronomica, in aggiunta ai moduli per il vino, si possono inserire moduli neutri, salumeria e gastronomia.

With type "D" modules it is possible to create either a counter-like solution using our FIT cladding, or a suspended composition using our frames.

To realize an elegant enogastronomic display in addition to bottle units it is possible to add also neutral units, delicatessen and gastronomy ones.

MODULI REFRIGERATI PER VINO

Wine cooling units



PH-VDR20

PM-VDR20

PC-VDR20

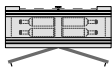

mm

363

900 x 363 x 903



24

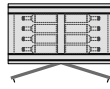

mm

515

900 x 515 x 903



48

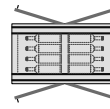

mm

520

900 x 520 x 903



48



PM-VDR22

PC-VDR22

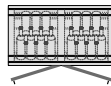
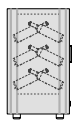

mm

515

900 x 515 x 903



42

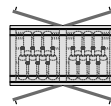

mm

520

900 x 520 x 903



42



PM-VDR23

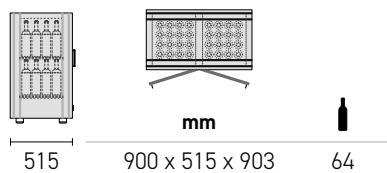

PC-VDR23

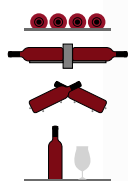
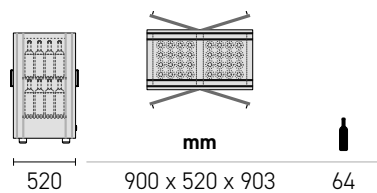

Allestimento interno personalizzabile
Custom internal layout



PH-VDR24



PM-VDR24

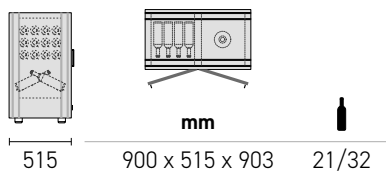

PC-VDR24

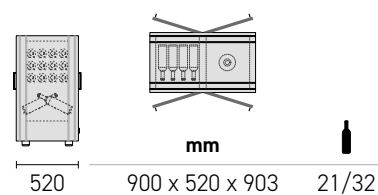



MODULI SALUMERIA

Salami modules



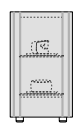

 +4 / +18

PM-SDR20

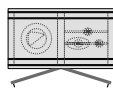

515



mm

900 x 515 x 903

PC-SDR20

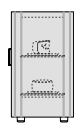

520

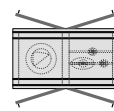

mm

900 x 520 x 903



MODULI GASTRONOMIA

Delicatessen modules



PH-GDR20

PM-GDR20

PC-GDR20



363

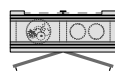

mm

900 x 363 x 903



515

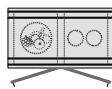

mm

900 x 515 x 903



520

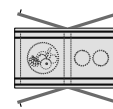

mm

900 x 520 x 903

MODULI CIOCCOLATO

Chocolate modules



PH-CDR20

PM-CDR20

PC-CDR20



363

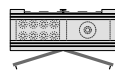

mm

900 x 363 x 903



515

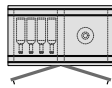

mm

900 x 515 x 903



520

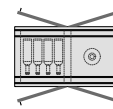

mm

900 x 520 x 903

MODULI NEUTRI - D

Neutral modules



PH-MD10

PM-MD10

PC-MD10

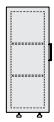

363

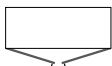

mm

900 x 363 x 903

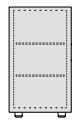

515

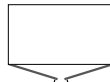

mm

900 x 515 x 903

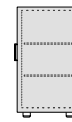

520

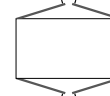

mm

900 x 520 x 903



Modulo realizzabile su misura da cm 20 a cm 90
Custom made unit from cm. 20 up to cm. 90

PH-MD20

PM-MD20

PC-MD20

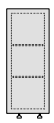

363

mm

900 x 363 x 903



515

mm

900 x 515 x 903



520

mm

900 x 520 x 903





PH-MD30

PM-MD30

PC-MD30

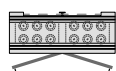
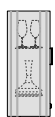

363

900 x 363 x 903

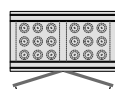

515

900 x 515 x 903

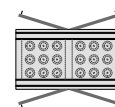
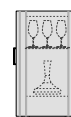

520

900 x 520 x 903



PH-MD40

PM-MD40

PC-MD40

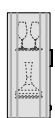

363

486 x 363 x 903



515

486 x 515 x 903

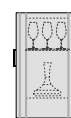

520

486 x 520 x 903



Mod

Composizione ad incasso su cavalletto composta da due PM-VAR10.
Cornice sagomata.

*Built-in composition on stands made with two PM-VAR10.
Style frame.*



FINISHES

CORNICE LINEARE

Plain frame



FN-CL

COLORS

L01 - L10 - L11 - L20 - L21 - L22 - L23 - L30
L40 - L42 - L50 - L51 - L52 - L53 - LM01 - LM02 - RAL

CORNICE SAGOMATA

Moulded frame

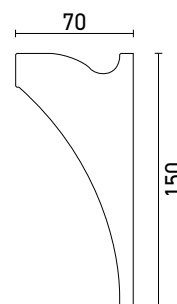

FN-CS

COLORS

A01 - LM01 - LM02 - RAL

PANNELLI LATERALI

Side panels



FN-PL

L'inserimento dei pannelli laterali è da prevedere esclusivamente nell'installazione "da appoggio" oppure "centrale".

Side panels are to be added exclusively in the case of "wall-back" or "central" installations.

COLORS

L01 - L10 - L11 - L20 - L21 - L22 - L23 - L30
L40 - L42 - L50 - L51 - L52 - L53 - LM01 - LM02 - RAL

RIVESTIMENTO FIT

Fit cladding



FN-RFA**

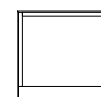

FN-RFD**

Rivestimento completo top, fianchi e frontalino.
Complete cladding for top, sides and front flap.

COLORS

L01 - L10 - L11 - L20 - L21 - L22 - L23 - L30
L40 - L42 - L50 - L51 - L52 - L53 - LM01 - LM02 - RAL



Emme 12





EM-12

mm		 °C
650 x 273 x 1696	12	+5 / +18

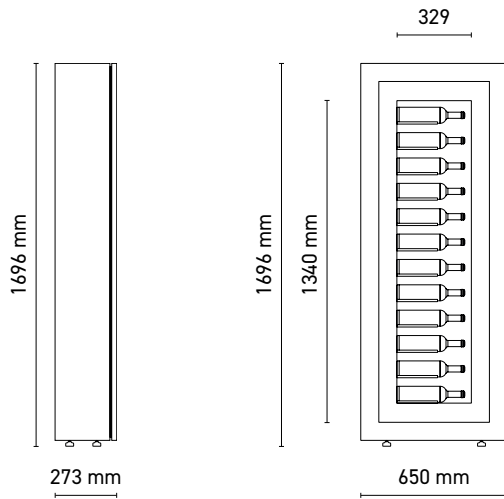



EM-12G

mm		 °C
650 x 273 x 1696	8	+5 / +18

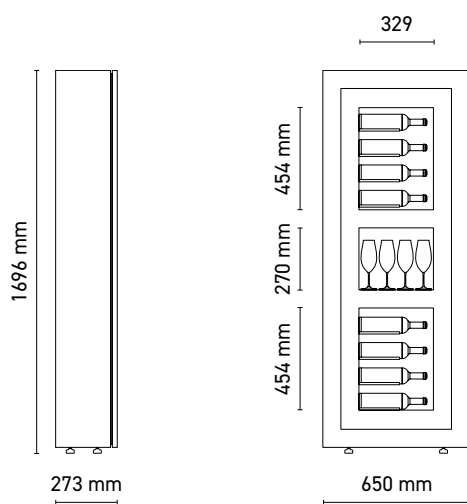

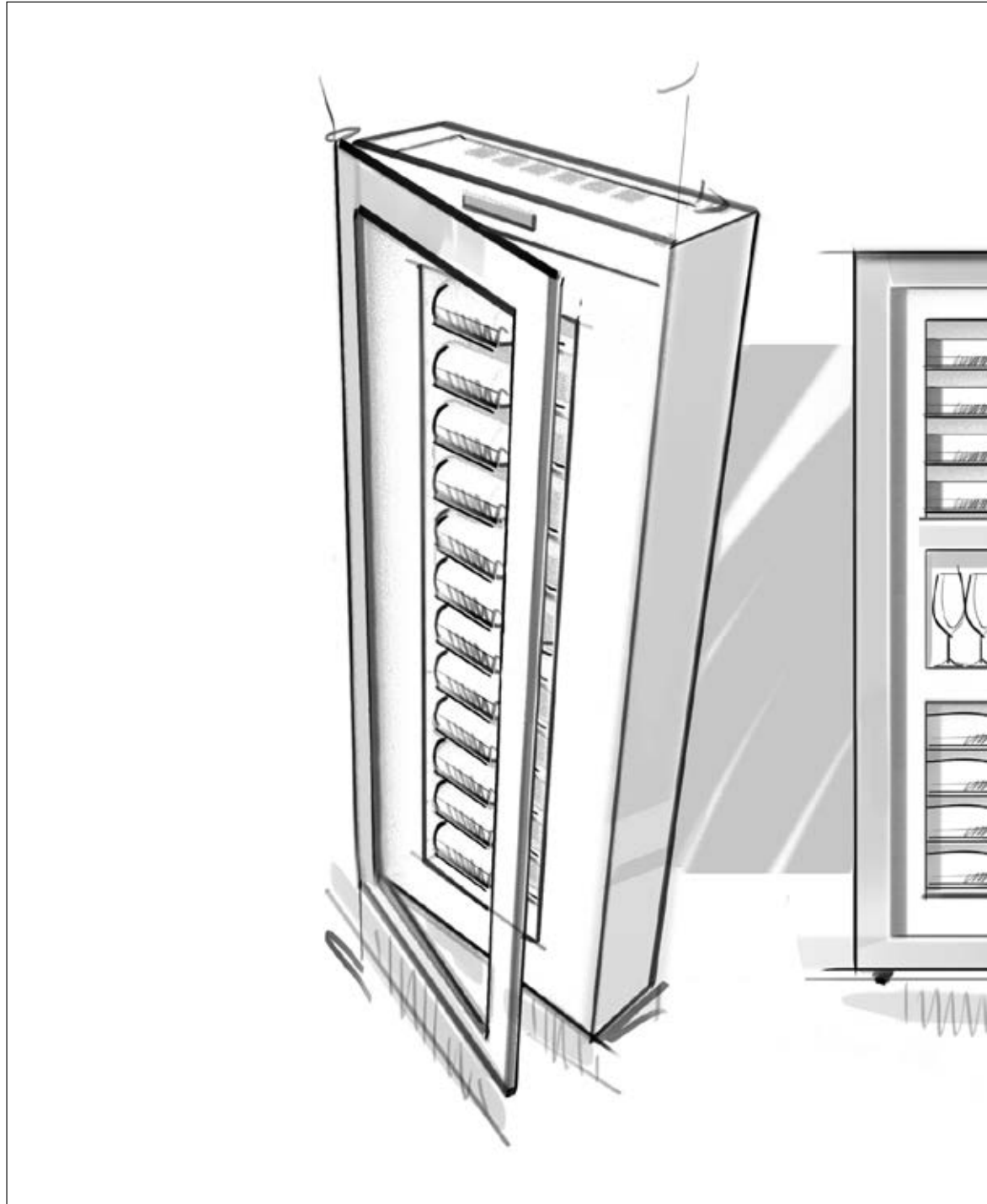

Emme 12

La Emme12 rappresenta la sintesi della vision del brand. Oggetto fortemente identitario segue il concept estetico della collezione Quadro Vino, facendo propria una tecnologia del freddo professionale. È in assoluto la vetrina per vino meno profonda al mondo. Le temperature differenziate consentono di conservare contemporaneamente sia vini bianchi che vini rossi.

Emme 12 represents a synthesis of the brand's vision. As a highly identitary object, it follows Quadro Vino's aesthetic concept, taking up technology from professional refrigeration. It is the world's slimmest wine cabinet. Differentiated temperatures allow for conservation of white and red wines at the same time.

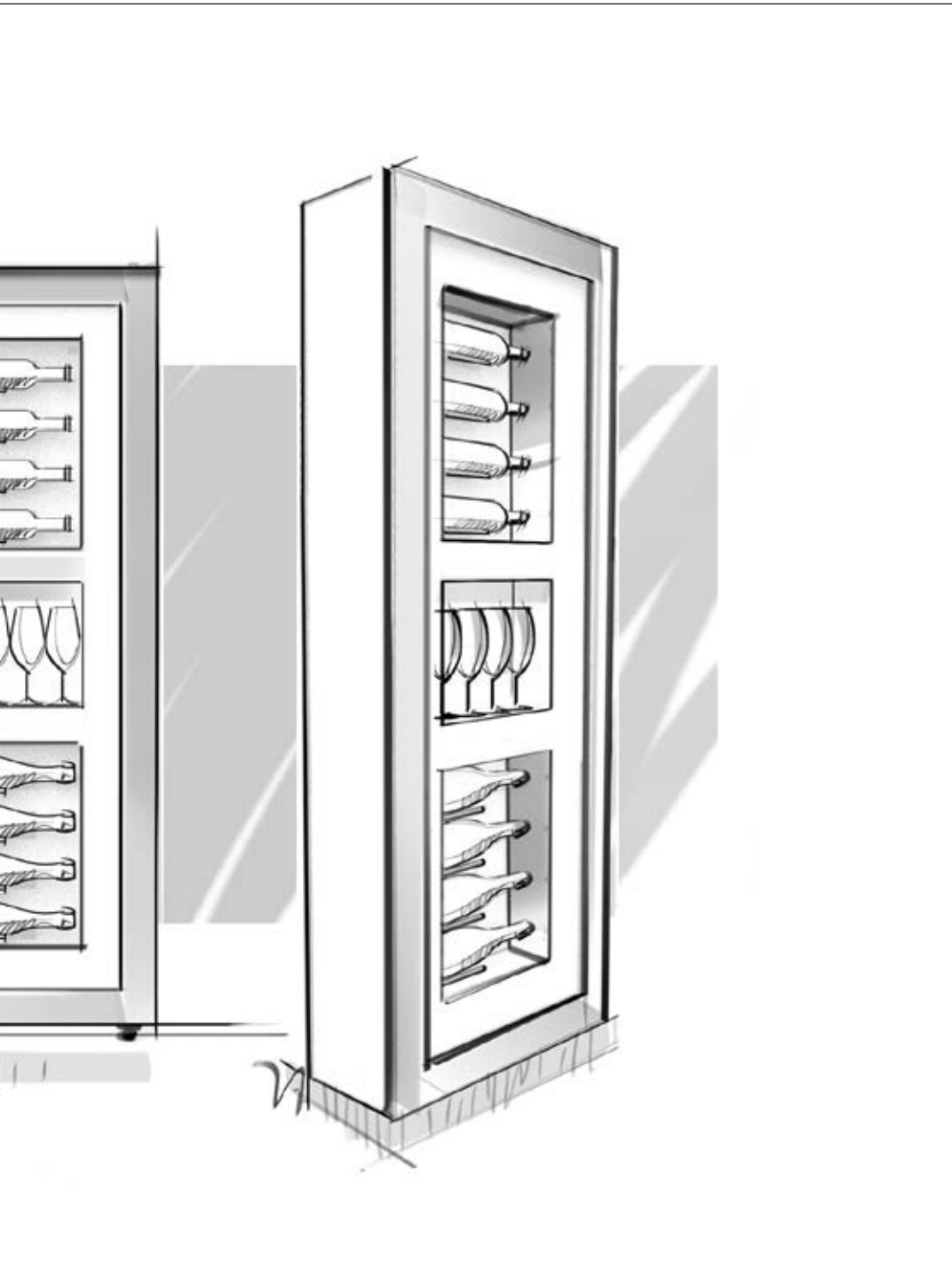



Quadro Vino



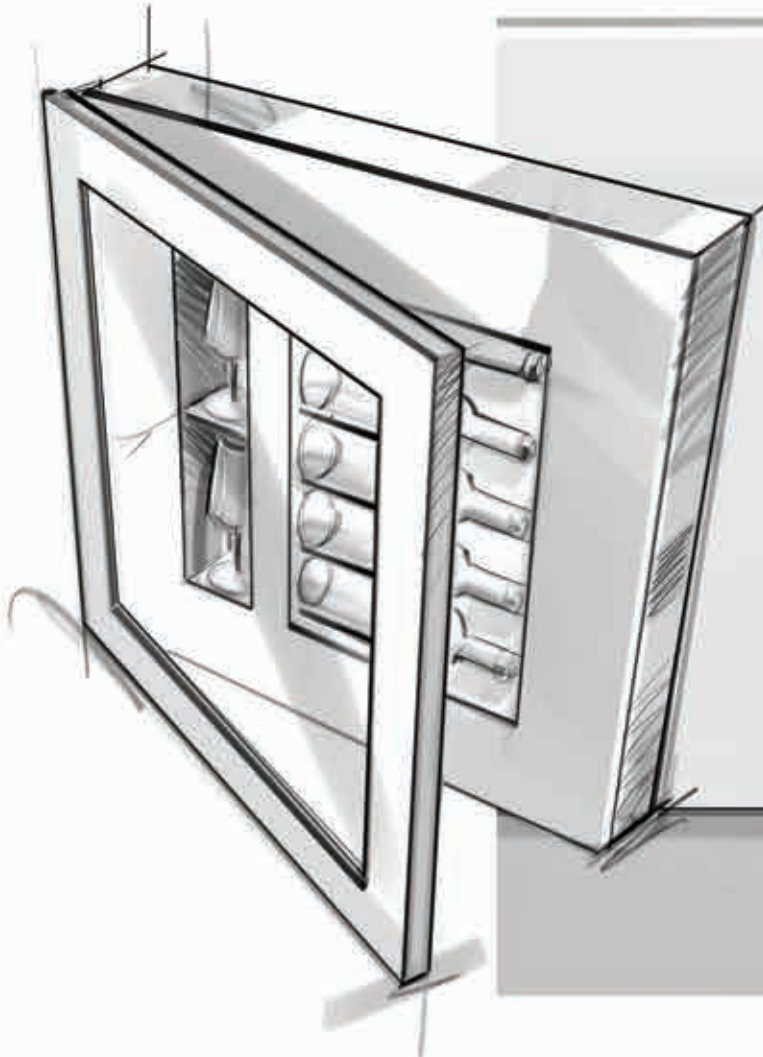

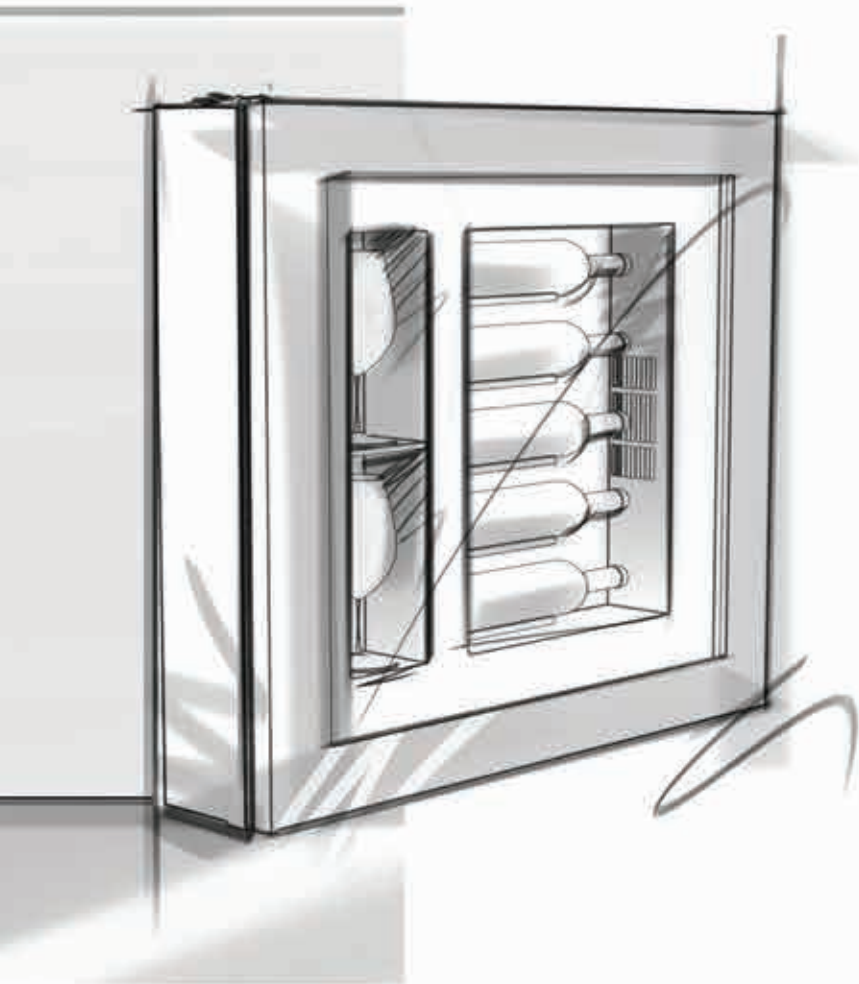

Q



Quadro Vino n. 12



QV12

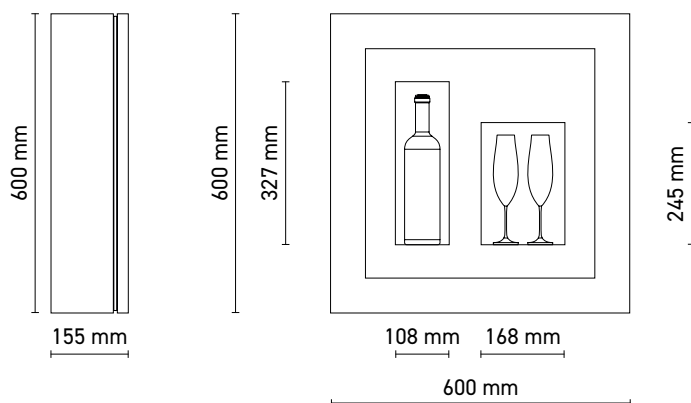

+4 / +10



Quadro Vino n. 30



QV30

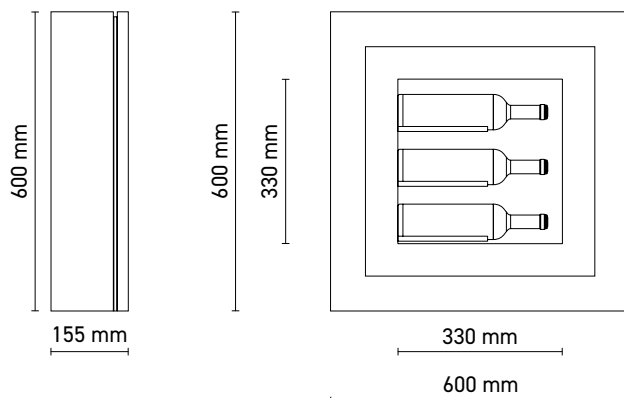

+ 8 / +20



Quadro Vino n. 40



QV40

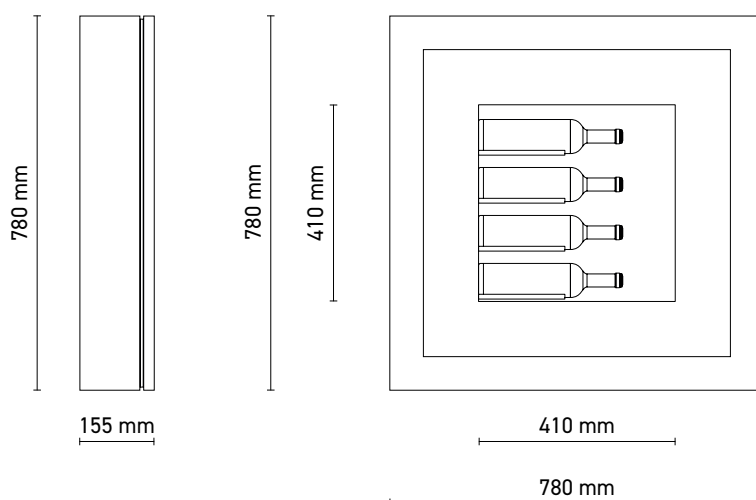

 °C
+ 12 / +20



Quadro Vino n. 52



QV52

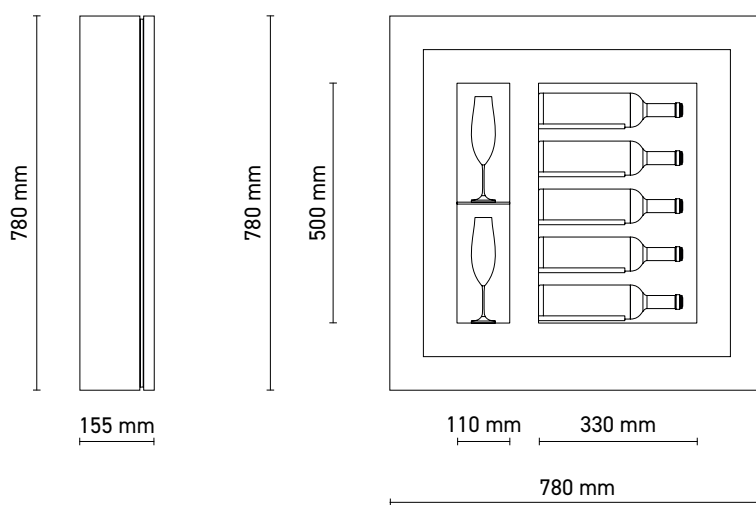

 °C
+ 12 / +20

AREA TECNICA

TECHNICAL AREA

Teca

La Teca ha una struttura in alluminio rivestita da una cornice in legno realizzabile con finiture e colori diversi. Questa scelta costruttiva permette di sostituire con semplicità sia le parti in vetro che la cornice in legno.

La Teca è disponibile nella versione a profondità ridotta (H) con condensatore statico installato nella parte posteriore e nella versione standard (M / C) dove è installato l'innovativo sistema di refrigerazione centrale basato sul posizionamento della serpentina di raffreddamento al centro della vetrina. Questo sistema consente la costruzione della vetrina centrale (C) con porte scorrevoli su entrambi i lati.

Teca features a wooden-clad aluminum structure that comes in different colors and finishes. This design choice allows for easy replacement both of glass parts and the wood frame.

Teca is available with reduced depth (H) with static condenser installed in the back, and standard depth (M / C) equipped with the innovative central refrigeration system with the cooling coil in the middle of the cabinet. This system makes it possible to have a central (C) system with sliding doors on both sides.

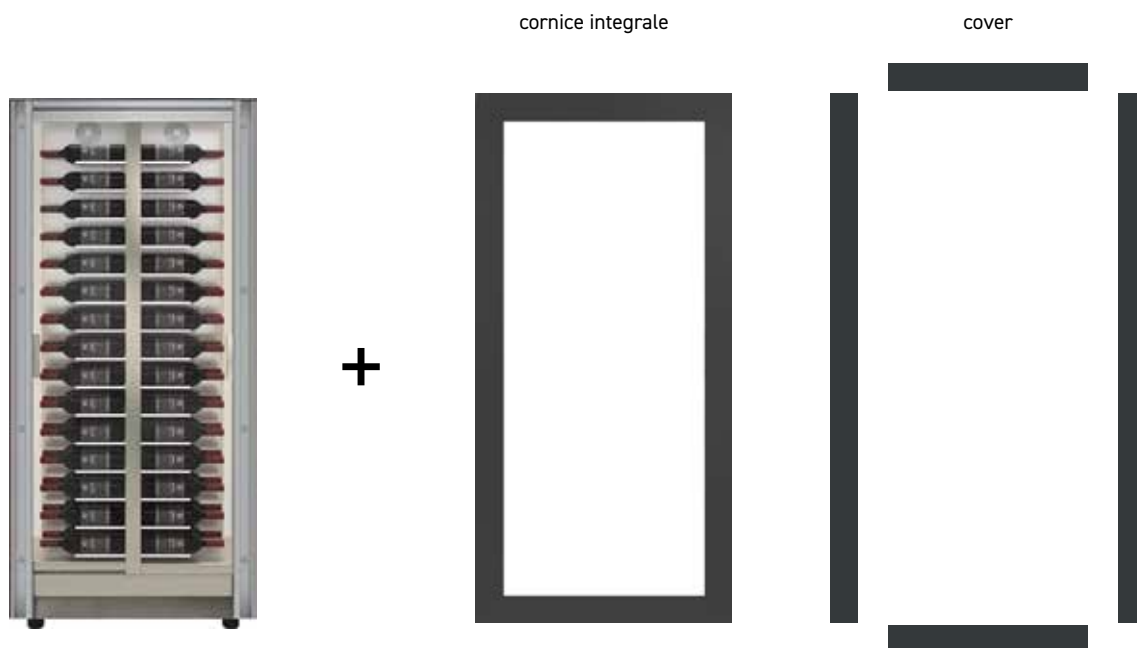

La Teca è composta da due elementi distinti che sono codificati e quotati separatamente:

- Vetrina con struttura in alluminio
- Cornice di finitura in legno/MDF
- Cover in HPL

La cornice frontale viene applicata con bottoni a pressione pertanto la sostituzione è semplice ed immediata.

Le cover vengono inserite con sistema a scorrimento.

Le finiture hanno un proprio codice e sono fornite separatamente.

Teca is made of two separate elements and references:

- Unit with aluminium structure
- Finishing frame in wood/MDF
- HPL covers

The frame is mounted with a snap-on button system and therefore easy to replace.

Covers are inserted thanks to a sliding system.

Each finish has its own reference, and are supplied separately.

CONFIGURATORE ONLINE

Online builder

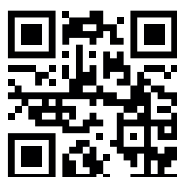

CARATTERISTICHE TECNICHE

Specifications

Struttura in alluminio
Cornice in legno/MDF
Cover in HPL
Porte scorrevoli, fianchi e top con vetrocamera - protezione UV
Serratura con chiave
Interni in alluminio
Illuminazione a LED bianco naturale
(4000 K - 60 led/mt - 4,8 W / mt - 130 lumen / mt - 12V)
Refrigerazione statica e ventilata
Termoregolatore digitale
Sbrinamento automatico
Sistema antivibrazione

*Aluminium structure
Frame in wood/MDF
HPL covers
Sliding doors, sides and top in double glass - anti-UV protection
Lock with key
Aluminium interior
Cold white daylight LED
(4000 K - 60 led/mt - 4,8 W / mt - 130 lumen / mt - 12V)
Static and ventilated refrigeration
Digital temperature controller
Automatic defrosting
Anti-vibration system*

I modelli TV-H10, TV-H14, TG-H10, TC-H10 devono essere fissati alla parete utilizzando le staffe in dotazione.

The TV-H10, TV-H14, TG-H10, TC-H10 models must be fixed to the wall with the provided brackets.

OPTIONAL DISPONIBILI SU TUTTI I MODELLI

Options available on all models

(Pag. 126)





OPT-RGB · OPT-CBD · OPT-TCR · OPT-RGB-CX · OPT-CBD-CX · OPT-ABK

COLORS



CODE	mm LxPxH			N. 0,75 LT		Class 	P _{nom} ↓ W		HF			dB
	mm LxPxH								H			
TV-H10	874 x 388 x 1865		60	293	SN-N	120	INV	R 600 a	NW	42		
	1000 x 800 x 2060							H 320 ∅ 93			230 50-60Hz	52
TV-M10	874 x 568 x 1865		120	540	SN-N	320	FIX	R 290	NW	47		
	1000 x 800 x 2060							H 320 ∅ 90			230 / 50Hz	95
TV-C10	874 x 568 x 1865		120	570	SN-N	320	FIX	R 290	NW	47		
	1000 x 800 x 2060							H 320 ∅ 90			230 / 50Hz	95
TV-H20	874 x 388 x 910		24	114	SN-N	120	INV	R 600 a	NW	42		
	1000 x 800 x 1120							H 320 ∅ 93			230 50-60Hz	25
TV-M20	874 x 568 x 910		48	220	SN-N	120	INV	R 600 a	NW	47		
	1000 x 800 x 1120							H 320 ∅ 90			230 50-60Hz	45
TV-C20	874 x 568 x 910		48	234	SN-N	120	INV	R 600 a	NW	47		
	1000 x 800 x 1120							H 320 ∅ 90			230 50-60Hz	45
TV-M12	874 x 568 x 1865		112	540	SN-N	320	FIX	R 290	NW	47		
	1000 x 800 x 2060							H 350 ∅ 95			230 / 50Hz	95
TV-C12	874 x 568 x 1865		112	570	SN-N	320	FIX	R 290	NW	47		
	1000 x 800 x 2060							H 350 ∅ 95			230 / 50Hz	95
TV-M22	874 x 568 x 910		42	220	SN-N	120	INV	R 600 a	NW	47		
	1000 x 800 x 1120							H 350 ∅ 95			230 50-60Hz	45
TV-C22	874 x 568 x 910		42	234	SN-N	120	INV	R 600 a	NW	47		
	1000 x 800 x 1120							H 350 ∅ 95			230 50-60Hz	45

Le dimensioni indicate comprendono la cornice lineare • Reported dimensions include linear frame

			
		OFF	ON

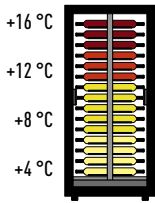
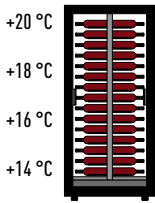
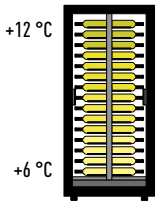
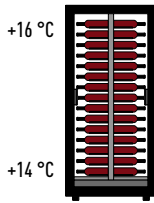
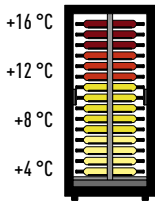
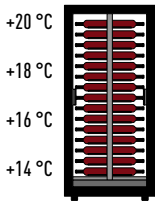
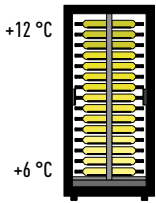
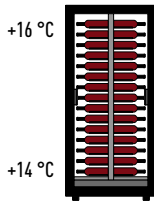
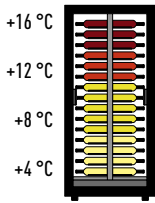
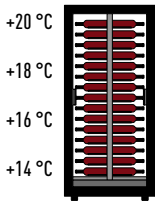
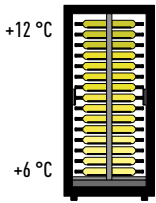
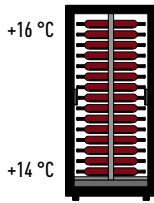
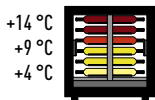
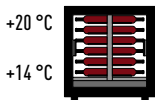
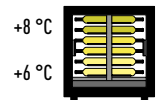
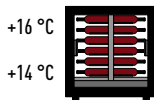
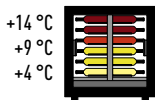
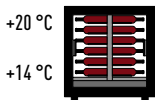
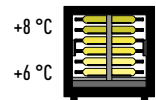
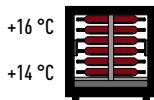
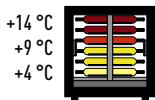
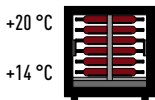
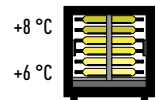
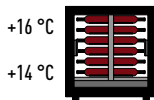
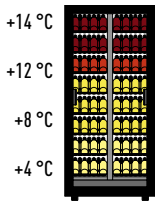
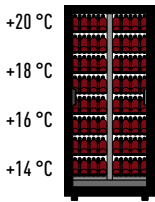
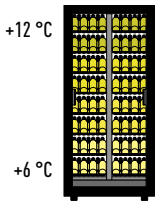
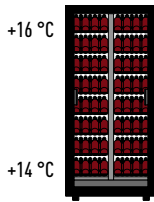
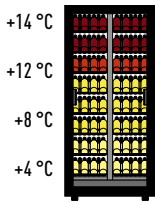
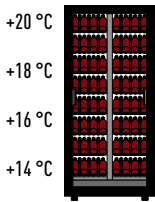
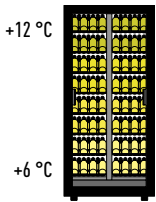
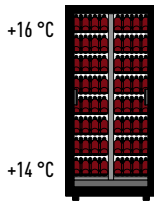
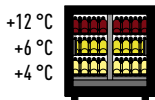
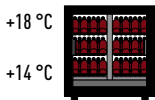
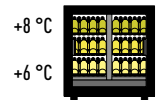
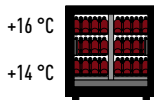
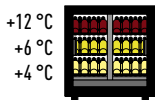
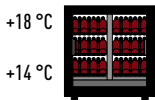
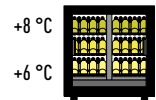
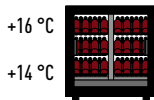
110	1,7	 	 
148			
138	1,7	 	 
170			
155	1,7	 	 
187			
50	0,9	 	 
78			
66	0,9	 	 
87			
73	0,9	 	 
94			
138	1,7	 	 
170			
155	1,7	 	 
187			
66	0,9	 	 
87			
73	0,9	 	 
94			

Le temperature riportate sono indicative e possono variare di (+ -) 2 °C. Rilevazioni effettuate con temperatura ambiente di 25 °C.
 Reported temperatures are approximate and may vary by (+ -) 2 °C. Detections made in 25 °C ambient temperature.





Teca

CODE	mm LxPxH			N. 0,75 LT		Class	P _{nom} ↓ W		HF			dB
	mm LxPxH			H					HF			
TV-M13	874 x 568 x 1865		128	540	SN-N	320	FIX	R 290	NW	47		
	1000 x 800 x 2060							-			230 / 50Hz	95
TV-C13	874 x 568 x 1865		128	570	SN-N	320	FIX	R 290	NW	47		
	1000 x 800 x 2060							-			230 / 50Hz	95
TV-M23	874 x 568 x 910		64	220	SN-N	120	INV	R 600 a	NW	47		
	1000 x 800 x 1120							-			230 50-60Hz	45
TV-C23	874 x 568 x 910		64	234	SN-N	120	INV	R 600 a	NW	47		
	1000 x 800 x 1120							-			230 50-60Hz	45
TV-H14 ^S	874 x 388 x 1865		OPT14	293	SN-N	120	INV	R 600 a	NW	42		
	1000 x 800 x 2060							-			230 50-60Hz	52
TV-M14 ^S	874 x 568 x 1865		OPT14	540	SN-N	320	FIX	R 290	NW	47		
	1000 x 800 x 2060							-			230 / 50Hz	95
TV-C14 ^S	874 x 568 x 1865		OPT14	570	SN-N	320	FIX	R 290	NW	47		
	1000 x 800 x 2060							-			230 / 50Hz	95
TV-H24 ^S	874 x 388 x 910		OPT14	114	SN-N	120	INV	R 600 a	NW	42		
	1000 x 800 x 1120							-			230 50-60Hz	25
TV-M24 ^S	874 x 568 x 910		OPT14	220	SN-N	120	INV	R 600 a	NW	47		
	1000 x 800 x 1120							-			230 50-60Hz	45
TV-C24 ^S	874 x 568 x 910		OPT14	234	SN-N	120	INV	R 600 a	NW	47		
	1000 x 800 x 1120							-			230 50-60Hz	45

Le dimensioni indicate comprendono la cornice lineare · Reported dimensions include linear frame

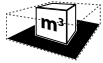
S. Senza allestimento interno · Without inside fittings

OPT14 - Pag. 128

			
		OFF	ON





138	1,7	+14 °C	+20 °C	+12 °C	+16 °C
170		+12 °C	+18 °C	+6 °C	+14 °C
155		+8 °C	+16 °C	+6 °C	+14 °C
187	1,7	+4 °C	+14 °C	SET 4 °C	SET 14 °C
187		SET 4 °C	SET 14 °C	SET 6 °C	SET 14 °C
70	0,9	+12 °C	+18 °C	+8 °C	+16 °C
91		+6 °C	+14 °C	+6 °C	+14 °C
77	0,9	+4 °C	SET 4 °C	SET 6 °C	SET 14 °C
98		SET 4 °C	SET 14 °C	SET 6 °C	SET 14 °C
110	1,7	+16 °C	+20 °C	+12 °C	+16 °C
148		+12 °C	+18 °C	+6 °C	+14 °C
138	1,7	+8 °C	+16 °C	SET 6 °C	SET 14 °C
170		+4 °C	+14 °C	SET 6 °C	SET 14 °C
155	1,7	SET 4 °C	SET 14 °C	SET 6 °C	SET 14 °C
187		SET 4 °C	SET 14 °C	SET 6 °C	SET 14 °C
59	0,9	+14 °C	+18 °C	+8 °C	+16 °C
77		+9 °C	+14 °C	+6 °C	+14 °C
64	0,9	+4 °C	SET 4 °C	SET 6 °C	SET 14 °C
85		SET 4 °C	SET 14 °C	SET 6 °C	SET 14 °C
71	0,9	SET 4 °C	SET 14 °C	SET 6 °C	SET 14 °C
92		SET 4 °C	SET 14 °C	SET 6 °C	SET 14 °C



Le temperature riportate sono indicative e possono variare di (+ -) 2 °C. Rilevazioni effettuate con temperatura ambiente di 25 °C.
 Reported temperatures are approximate and may vary by (+ -) 2 °C. Detections made in 25 °C ambient temperature.



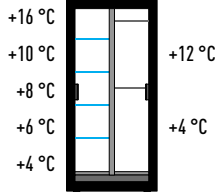
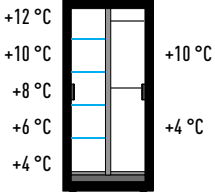
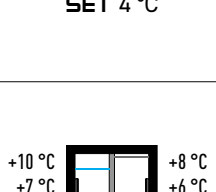
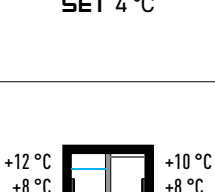
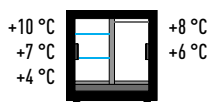

Teca

CODE	 mm LxPxH				Class		P _{nom} ↓ W				 dB
	 mm LxPxH										
Teca Salumeria											
	TS-M10	874 x 568 x 1865		4	540	SN-N	310	FIX	R 290	NW	47
			1000 x 800 x 2060			4			230 / 50Hz		
	TS-C10	874 x 568 x 1865		4	570	SN-N	310	FIX	R 290	NW	47
			1000 x 800 x 2060			4			230 / 50Hz		
	TS-M20	874 x 568 x 910		2	220	SN-N	120	INV	R 600 a	NW	47
			1000 x 800 x 1120			2			230 / 50-60Hz		
	TS-C20	874 x 568 x 910		2	234	230	120	INV	R 600 a	NW	47
			1000 x 800 x 1120			2			50-60Hz		
Teca Gastronomia											
	TG-H10	874 x 388 x 1865		8	293	SN-N	120	INV	R 600 a	NW	42
			1000 x 800 x 2060			-			230 / 50-60Hz		
	TG-M10	874 x 568 x 1865		8	540	SN-N	310	FIX	R 290	NW	47
			1000 x 800 x 2060			-			230 / 50Hz		
	TG-C10	874 x 568 x 1865		8	570	SN-N	310	FIX	R 290	NW	47
			1000 x 800 x 2060			-			230 / 50Hz		
	TG-H20	874 x 388 x 910		4	114	SN-N	120	INV	R 600 a	NW	42
			1000 x 800 x 1120			-			230 / 50-60Hz		
	TG-M20	874 x 568 x 910		4	220	SN-N	120	INV	R 600 a	NW	47
			1000 x 800 x 1120			-			230 / 50-60Hz		
	TG-C20	874 x 568 x 910		4	234	SN-N	120	INV	R 600 a	NW	47
			1000 x 800 x 1120			-			230 / 50-60Hz		

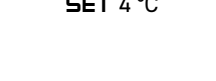
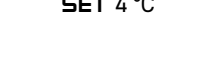
Le dimensioni indicate comprendono la cornice lineare - Reported dimensions include linear frame

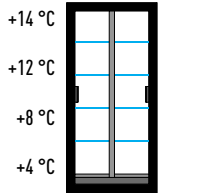
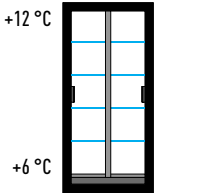
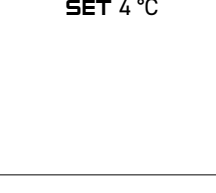
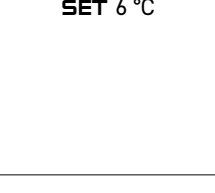
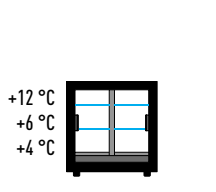
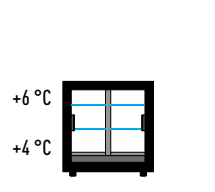
			
		OFF	ON

138	1,7	 <p>SET 4 °C</p>	 <p>SET 4 °C</p>
170			
155	1,7	 <p>SET 4 °C</p>	 <p>SET 4 °C</p>
187			
68	0,9	 <p>SET 4 °C</p>	 <p>SET 4 °C</p>
89			
75	0,9	 <p>SET 4 °C</p>	 <p>SET 4 °C</p>
96			

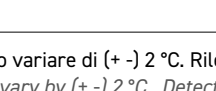
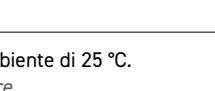



110	1,7	 <p>SET 4 °C</p>	 <p>SET 6 °C</p>
148			
138	1,7	 <p>SET 4 °C</p>	 <p>SET 6 °C</p>
170			
155	1,7	 <p>SET 4 °C</p>	 <p>SET 4 °C</p>
187			
59	0,9	 <p>SET 4 °C</p>	 <p>SET 4 °C</p>
77			
64	0,9	 <p>SET 4 °C</p>	 <p>SET 4 °C</p>
85			
71	0,9	 <p>SET 4 °C</p>	 <p>SET 4 °C</p>
92			

Le temperature riportate sono indicative e possono variare di (+ -) 2 °C. Rilevazioni effettuate con temperatura ambiente di 25 °C.
 Reported temperatures are approximate and may vary by (+ -) 2 °C. Detections made in 25 °C ambient temperature.

Teca

CODE	mm LxPxH					Class 	P _{nom}		HF		
	mm LxPxH										
Teca Cioccolato											
	TC-H10	874 x 388 x 1865		12	293	SN-N	120	INV	R 600 a	CCT	42
		1000 x 800 x 2060		-		230 50-60Hz			52		
	TC-M10	874 x 568 x 1865		12	540	SN-N	320	FIX	R 290	CCT	47
		1000 x 800 x 2060		-		230 / 50Hz			95		
	TC-C10	874 x 568 x 1865		12	570	SN-N	320	FIX	R 290	CCT	47
		1000 x 800 x 2060		-		230 / 50Hz			95		
	TC-H20	874 x 388 x 910		4	114	SN-N	120	INV	R 600 a	CCT	42
		1000 x 800 x 1120		-		230 50-60Hz			25		
	TC-M20	874 x 568 x 910		4	220	SN-N	120	INV	R 600 a	CCT	47
		1000 x 800 x 1120		-		230 50-60Hz			45		
	TC-C20	874 x 568 x 910		4	234	SN-N	120	INV	R 600 a	CCT	47
		1000 x 800 x 1120		-		230 50-60Hz			45		

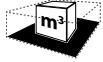

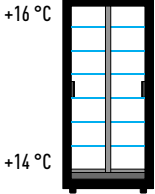
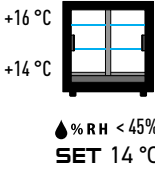

Le dimensioni indicate comprendono la cornice lineare • Reported dimensions include linear frame

 		 OFF	 ON
---	---	--	---





110 <hr/> 148	1,7		
138 <hr/> 170	1,7	-	 % RH < 45% SET 14 °C
155 <hr/> 187	1,7		
59 <hr/> 77	0,9		
69 <hr/> 90	0,9	-	 % RH < 45% SET 14 °C
76 <hr/> 97	0,9		

Le temperature riportate sono indicative e possono variare di (+ -) 2 °C. Rilevazioni effettuate con temperatura ambiente di 25 °C.
Reported temperatures are approximate and may vary by (+ -) 2 °C. Detections made in 25 °C ambient temperature.

CORNICI

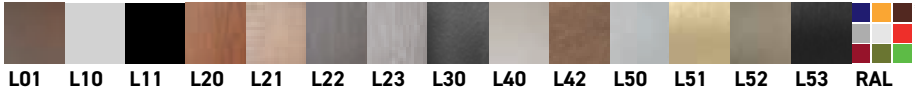

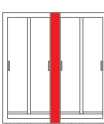

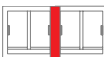
CODE													
	M01	LM01	LM02	RAL 9005	RAL 9010	RAL	D01	DLM01	DLM02	C01	CLM01	CLM02	CRAL
	T1-H*			•				•				•	
	T1-M*			•				•				•	
	T1-C*			•				•				•	
	T2-H*			•				•				•	
	T2-M*			•				•				•	
	T2-C*			•				•				•	





COVER

CODE															
	L01	L10	L11	L20	L21	L22	L23	L30	L40	L42	L50	L51	L52	L53	RAL
	TM1-H-								•						
	TM1-M-								•						
	TM1-C-								•						
	TM1-H-U-								•						
	TM1-M-U-								•						
	TM1-C-U-								•						
	TM2-H-								•						
	TM2-M-								•						
	TM2-C-								•						
	TM2-H-U-								•						
	TM2-M-U-								•						
	TM2-C-U-								•						

* I colori RAL vengono realizzati su supporto di MDF in finitura opaca 20 gloss.

* RAL colours are made on MDF 20-gloss matte finish.

			
874 x 1828 x 10	6	70	0,45
874 x 1828 x 10	6	70	0,45
874 x 1828 x 10	12	70	0,45
874 x 873 x 10	4	60	0,23
874 x 873 x 10	4	60	0,23
874 x 873 x 10	8	60	0,23

			
1850 x 200 x 60	3	7	0,03
1850 x 200 x 60	3	7	0,03
1850 x 200 x 60	4	8	0,03
1850 x 200 x 60	1,5	5,5	0,03
1850 x 200 x 60	1,5	5,5	0,03
1850 x 200 x 60	1,8	5,8	0,03
900 x 200 x 60	1,5	5,5	0,01
900 x 200 x 60	1,5	5,5	0,01
900 x 200 x 60	2	6	0,01
900 x 200 x 60	0,6	4,6	0,01
900 x 200 x 60	0,6	4,6	0,01
900 x 200 x 60	0,8	4,8	0,01

Teca B

Design Reg. n. TO 2009/31

Versione ad incasso della vetrina Teca.

La Teca B è semplice da installare in nicchie o passaggi inutilizzati.

La cornice è applicata con sistema ad incastro per cui facilmente sostituibile per qualsiasi esigenza tecnica o commerciale.

Built-in version of the Teca cabinet.

Teca B is easy to install in recesses or unused spaces.

The frame is mounted with a snap-on system and therefore easily replaced for any technical or sales need.

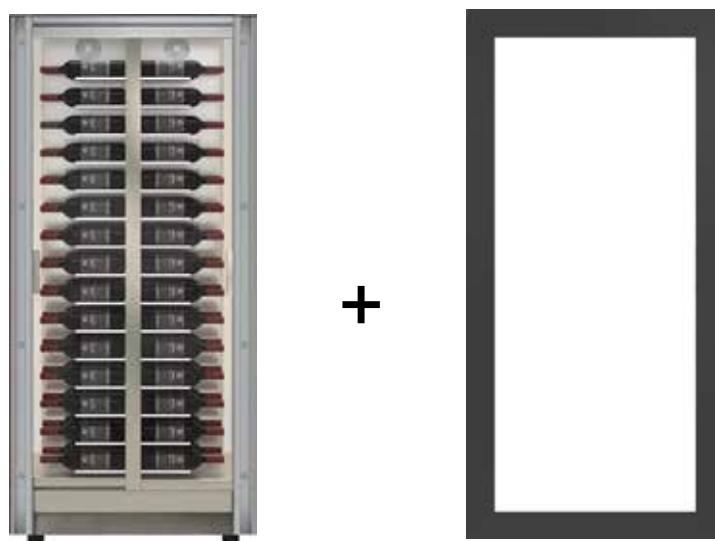

La Teca B è composta da due elementi distinti che sono codificati e quotati separatamente:

- Vetrina con struttura in alluminio
- Cornice di finitura in legno/MDF/HPL

La cornice frontale viene applicata con bottoni a pressione pertanto la sostituzione è semplice ed immediata.

Teca B is made of two separate elements and references:

- Unit with aluminium structure
- MDF/HPL/wood decorative frame.

The frame is mounted with a snap-on button system and therefore easy to replace.

COLORS

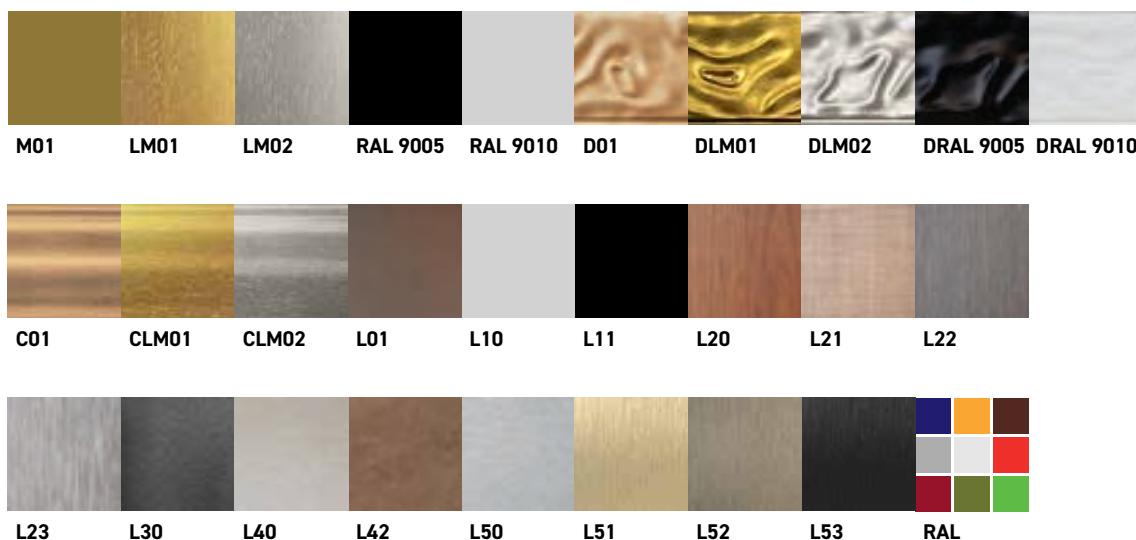

MISURE PER INCASSO A PARETE

Built-in installation dimensions

Dimensioni nicchia per incasso a parete (TB-H*)
Recess measures for building-in (TB-H)*

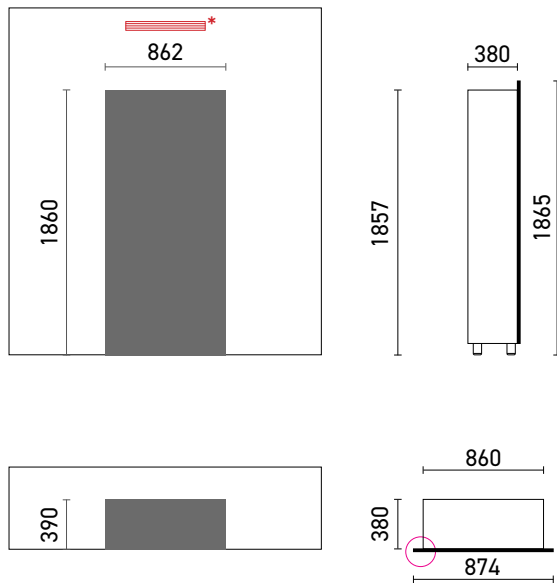

Dimensioni nicchia per incasso a parete (TB-M*)
Recess measures for building-in (TB-M)*

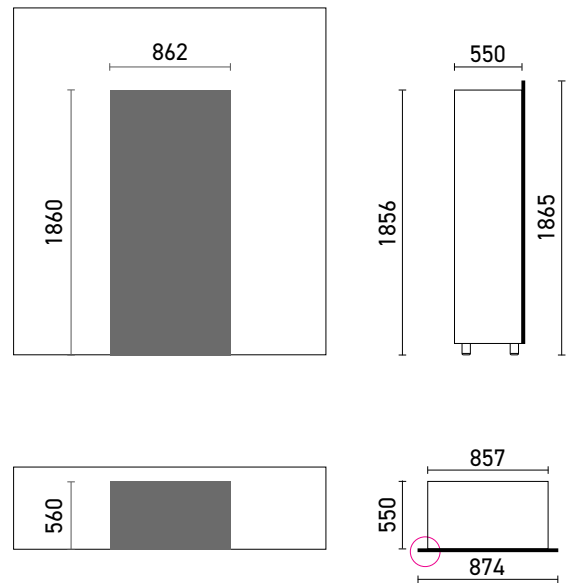

	HPL	7 mm
	MDF	10 mm
	DUNE	17 mm
	CLASSICA	27 mm

I modelli TB-H* devono essere fissati alla parete utilizzando le staffe in dotazione.

The TB-H* models must be fixed to the wall with the provided brackets.

* Prevedere nella parte alta della parete dove viene incassata la vetrina un'apertura di circa 160 cm² (ad esempio cm 80x2) che consenta la fuoriuscita dell'aria calda (solo TB*-H).

* Include an opening of about 160 cm² (for example, cm 80x2) above the niche in which the showcase is built in to allow the discharge of warm air (only TB*-H).

CARATTERISTICHE COSTRUTTIVE

Features





Struttura in alluminio
 Cornice in HPL/MDF
 Porte scorrevoli con vetrocamera - protezione UV
 Serratura con chiave
 Fianchi e top in pannelli di schiuma poliuretanic
 Interni in alluminio
 Illuminazione a LED bianco naturale
 (4000 K - 60 led/mt - 4,8 W/mt - 572 lumen/mt)
 Compressore ad inverter (H)
 Refrigerazione statica e ventilata
 Termoregolatore digitale
 Sbrinamento automatico ed evaporazione automatica della condensa
 Sistema di antivibrazione

Aluminium structure
 HPL/MDF frame
 Sliding doors in double glass - anti-UV protection
 Lock with key
 Sides and top panels polyurethane foam
 Aluminium interior
 White natural daylight LED
 (4000 K - 60 led/mt - 4,8 W/mt - 572 lumen/mt)
 Inverter compressor (H)
 Static and ventilated refrigeration
 Digital temperature controller
 Automatic defrosting and automatic evaporation system
 Anti-vibration system

Teca B Built-in/Incasso

CODE	mm LxPxH		N. 0,75 LT	H	LT	Class ⚡	P _{nom} ↓ W	HF	LIGHT	dB
	mm LxPxH									
 TBV-H10	874 x 388 x 1865		60			SN-N		R 600 a		
	1000 x 800 x 2060		H 320 ∅ 93	293		230 50-60Hz	120	INV	52	NW
 TBV-M10	874 x 557 x 1865		120			SN-N		R 290		
	1000 x 800 x 2060		H 320 ∅ 90	540		230 / 50Hz	320	FIX	95	NW
 TBV-C10	874 x 568 x 1865		120			SN-N		R 290		
	1000 x 800 x 2060		H 320 ∅ 90	540		230 / 50Hz	320	FIX	95	NW
 TBV-M12	874 x 557 x 1865		112			SN-N		R 290		
	1000 x 800 x 2060		H 350 ∅ 95	540		230 / 50Hz	320	FIX	95	NW
 TBV-C12	874 x 568 x 1865		112			SN-N		R 290		
	1000 x 800 x 2060		H 350 ∅ 95	540		230 / 50Hz	320	FIX	95	NW
 TBV-M13	874 x 557 x 1865		128			SN-N		R 290		
	1000 x 800 x 2060		-	540		230 / 50Hz	320	FIX	95	NW
 TBV-C13	874 x 568 x 1865		128			SN-N		R 290		
	1000 x 800 x 2060		-	540		230 / 50Hz	320	FIX	95	NW

Le dimensioni indicate comprendono la cornice lineare - Reported dimensions include linear frame

			
		OFF	ON

97	1,7				
135					
109	1,7	+16 °C	+20 °C	+12 °C	+16 °C
141		+12 °C	+18 °C	+6 °C	+14 °C
		+8 °C	+16 °C		
		+4 °C	+14 °C		
		SET 4 °C	SET 14 °C	SET 6 °C	SET 14 °C
109	1,7				
141					
109	1,7	+14 °C	+20 °C	+12 °C	+16 °C
141		+12 °C	+18 °C	+6 °C	+14 °C
		+8 °C	+16 °C		
		+4 °C	+14 °C		
		SET 4 °C	SET 14 °C	SET 6 °C	SET 14 °C
109	1,7				
141					
116	1,7	+14 °C	+20 °C	+12 °C	+16 °C
122		+12 °C	+18 °C	+6 °C	+14 °C
		+8 °C	+16 °C		
		+4 °C	+14 °C		
		SET 4 °C	SET 14 °C	SET 6 °C	SET 14 °C
116	1,7				
122					

Le temperature riportate sono indicative e possono variare di (+ -) 2 °C. Rilevazioni effettuate con temperatura ambiente di 25 °C.
 Reported temperatures are approximate and may vary by (+ -) 2 °C. Detections made in 25 °C ambient temperature.

Teca B Built-in/Incasso

CODE	mm LxPxH		N. 0,75 LT		Class	Pnom ↓ W		HF	LIGHT	dB
	mm LxPxH		H ∅							

MODULI REFRIGERATI PER VINO • Wine cooling units

	874 x 388 x 1865		OPT14	293	SN-N	120	INV	R 600 a	NW	42
	1000 x 800 x 2060							230 50-60Hz		
	874 x 557 x 1865		OPT14	540	SN-N	320	FIX	R 290	NW	47
	1000 x 800 x 2060							230 / 50Hz		
	874 x 568 x 1856		OPT14	540	SN-N	320	FIX	R 290	NW	47
	1000 x 800 x 2060							230 / 50Hz		

S. Senza allestimento interno • Without inside fittings

OPT14 - Pag. 128







CODE	mm LxPxH				Class	Pnom ↓ W		HF	LIGHT	dB
	mm LxPxH									



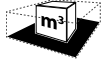

Teca B Salumeria

	874 x 557 x 1865		4	540	SN-N	320	FIX	R 290	NW	47
	1000 x 800 x 2060		4					230 / 50Hz		
	874 x 568 x 1856		4	540	SN-N	320	FIX	R 290	NW	47
	1000 x 800 x 2060		4					230 / 50Hz		

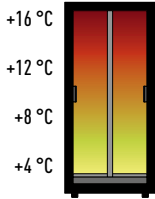
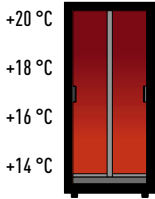
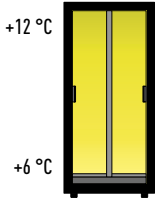
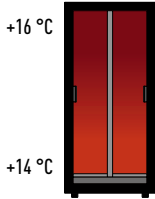
Le dimensioni indicate comprendono la cornice lineare • Reported dimensions include linear frame

			
		OFF	ON





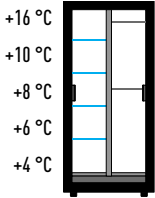
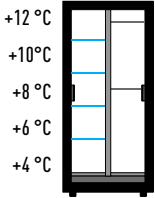





97	1,7	 	 
135			
97	1,7		
141			
97	1,7		
141			

			
		OFF	ON







103	1,7		
128			
103	1,7		
128			

Le temperature riportate sono indicative e possono variare di (+ -) 2 °C. Rilevazioni effettuate con temperatura ambiente di 25 °C.
 Reported temperatures are approximate and may vary by (+ -) 2 °C. Detections made in 25 °C ambient temperature.







Teca B Built-in/Incasso

CODE	 mm LxPxH				Class			HF		
	 mm LxPxH									

Teca B Gastronomia



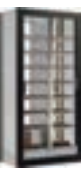

	TBG-H10	874 x 388 x 1865		8	293	SN-N	120	INV	R 600 a	NW	42
		1000 x 800 x 2060		-		230 50-60Hz			52		
	TBG-M10	874 x 557 x 1865		8	540	SN-N	320	FIX	R 290	NW	47
		1000 x 800 x 2060		-		230 / 50Hz			95		
	TBG-C10	874 x 568 x 1856		8	540	SN-N	320	FIX	R 290	NW	47
		1000 x 800 x 2060		-		230 / 50Hz			95		

Teca B Cioccolato



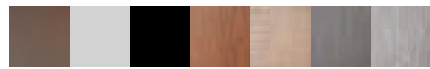
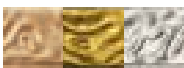

	TBC-H10	874 x 388 x 1865		14	293	SN-N	120	INV	R 600 a	CCT	42
		1000 x 800 x 2060		-		230 50-60Hz			52		
	TBC-M10	874 x 557 x 1865		14	540	SN-N	320	FIX	R 290	CCT	47
		1000 x 800 x 2060		-		230 / 50Hz			95		
	TBC-C10	874 x 568 x 1856		14	540	SN-N	320	FIX	R 290	CCT	47
		1000 x 800 x 2060		-		230 / 50Hz			95		

Le dimensioni indicate comprendono la cornice lineare - Reported dimensions include linear frame

CORNICI

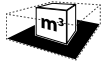
CODE	 L01 L10 L11 L20 L21 L22 L23							Dune  D01 DLM01 DLM02			Classica  C01 CLM01 CLM02 CRAL				
		 L30 L40 L42 L50 L51 L52 L53							 DRAL 9005 DRAL 9010 DRAL						
	TB1-	•							•			•			



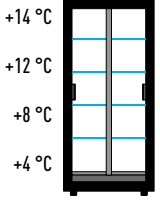
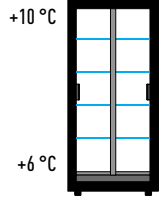
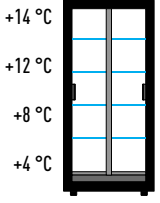
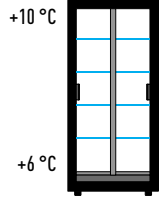
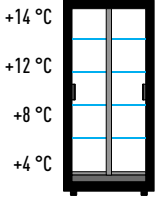
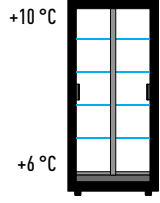

* I colori RAL vengono realizzati su supporto di MDF in finitura opaca 20 gloss. - * RAL colours are made on MDF 20-gloss matte finish.

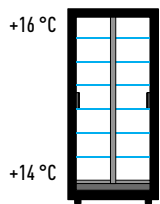
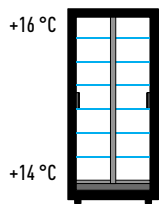
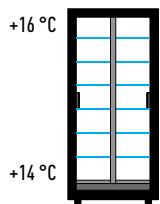
			
		OFF	ON

98	1,7		
106			
107	1,7		
132			
107	1,7		
132			

99	1,7	-	
107			
112	1,7	-	
137			
112	1,7	-	
137			

Le temperature riportate sono indicative e possono variare di (+ -) 2 °C. Rilevazioni effettuate con temperatura ambiente di 25 °C.
 Reported temperatures are approximate and may vary by (+ -) 2 °C. Detections made in 25 °C ambient temperature.

			
874 x 1828 x 10	6	70	0,45

Mod

È un sistema componibile. Si possono unire tra loro due o più modelli di vetrine diverse.

La composizione deve essere completata con l'inserimento delle cornici o del rivestimento Fit.

Modular system – two or more different models of cabinet can be combined together.

The composition has to be fitted with frames or Fit cladding.

CARATTERISTICHE COSTRUTTIVE

Features

Struttura in alluminio

Porte a battente con vetrocamera - protezione UV

Serratura con chiave

Fianchi e top in pannelli di schiuma poliuretanic

Interni in alluminio

Illuminazione a LED bianco naturale
(4000 K - 30 led/mt - 7,2 W/mt - 572 lumen/mt)

Compressore ad inverter (H)

Refrigerazione statica e ventilata

Termoregolatore digitale

Sbrinamento automatico ed evaporazione automatica della condensa

Sistema di antivibrazione

Aluminium structure

Hinged doors with double glazing – UV protection

Lock with key

Sides and top panels polyurethane foam

Aluminium interior

*White natural daylight LED
(4000 K - 30 led/mt - 7,2 W/mt - 572 lumen/mt)*

Inverter compressor (H)

Static and ventilated refrigeration

Digital temperature controller

Automatic defrosting and automatic evaporation system

Anti-vibration system

I modelli PH-* devono essere fissati alla parete utilizzando le staffe in dotazione.

The PH-* models must be fixed to the wall with the provided brackets.



CONFIGURATORE ONLINE

Online builder



INSTALLAZIONE CON CORNICE

Frame installation



Appoggio

Nell'installazione ad appoggio possono essere inseriti uno o più dei seguenti modelli (con il lato posteriore chiuso): MD-H10 · MD-M10 · MD-M12 · MD-H14 · MD-M14. Occorre inoltre completare la composizione aggiungendo una cornice e due pannelli laterali oppure il rivestimento Fit.

Standing

In a standing installation, one or more of the following modules can be included (closed back side): MD-H10 · MD-M10 · MD-M12 · MD-H14 · MD-M14. It is also necessary to complete the composition by adding one frame and two side panels or a Fit cladding.



Centrale

Nell'installazione centrale possono essere inseriti uno o più dei seguenti modelli (porte apribili su entrambi i lati): MD-C10 · MD-C12 · MD-C14.

Occorre inoltre completare la composizione aggiungendo due cornici, una per ciascun lato, e due pannelli laterali oppure il rivestimento Fit.

Central

In a central installation one or more of the following modules can be included (doors on both sides): MD-C10 · MD-C12 · MD-C14. It is also necessary to complete the composition by adding two frames (one for each side) and two side panels or a Fit cladding.



Incasso

Nell'installazione ad incasso possono essere inseriti uno o più dei seguenti modelli (con il lato posteriore chiuso): MD-H10 · MD-M10 · MD-M12 · MD-H14 · MD-M14.

Occorre inoltre completare la composizione aggiungendo una cornice. Non occorrono i pannelli laterali.

Built-in

In a built-in installation, one or more of the following modules can be included (closed back side): MD-H10 · MD-M10 · MD-M12 · MD-H14 · MD-M14.

It is also necessary to complete the composition by adding one frame. No side panels needed.

COLORS



Cornici Frame

CORNICE LINEARE (CL)
PLAIN FRAME (CL)



CORNICE SAGOMATA (CS)
MOULDED FRAME (CS)

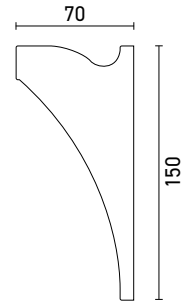

FN-CS1A	FN-CS2A	FN-CS3A	FN-CS1AB	FN-CS2AB	FN-CS3AB
FN-CL1A	FN-CL2A	FN-CL3A	FN-CL1AB	FN-CL2AB	FN-CL3AB

Pannelli laterali Side panels

L'inserimento dei pannelli laterali è da prevedere esclusivamente nel caso in cui si opti per l'installazione "da appoggio" oppure "centrale". Salvo diverse specifiche viene applicato lo stesso colore della cornice.

Side panels are to be added exclusively in the case of "wall-back" or "central" installations. Unless otherwise requested, side panels are supplied in the same finish as the frame.

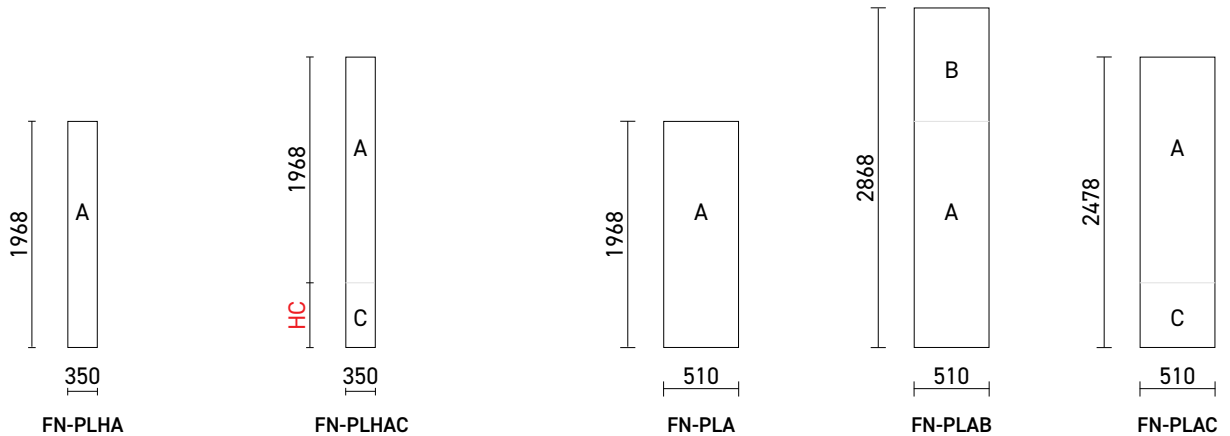

Rivestimento Fit Fit cladding

Rivestimento completo top, fianchi e frontalino
Complete cladding for top, sides and front flap

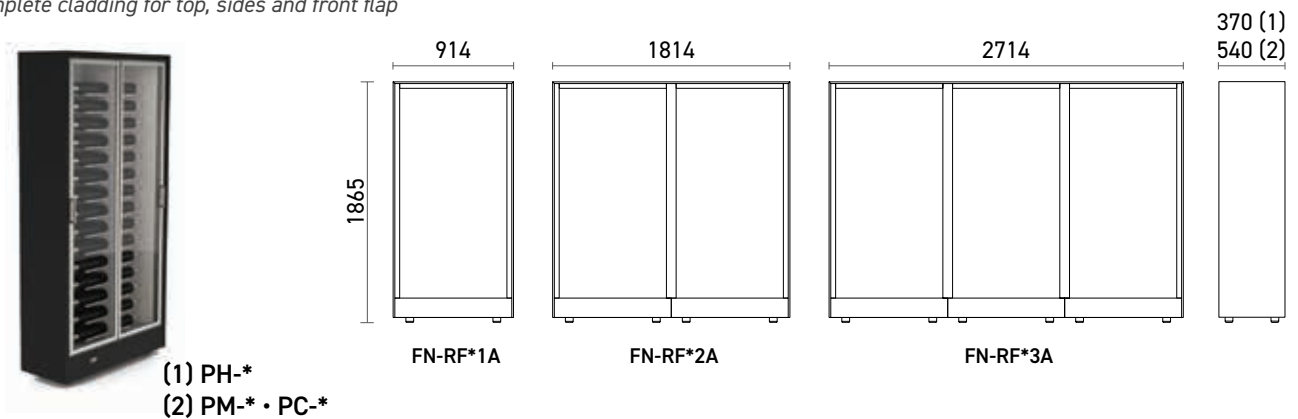

Misure per incasso a parete

Size of built-in units

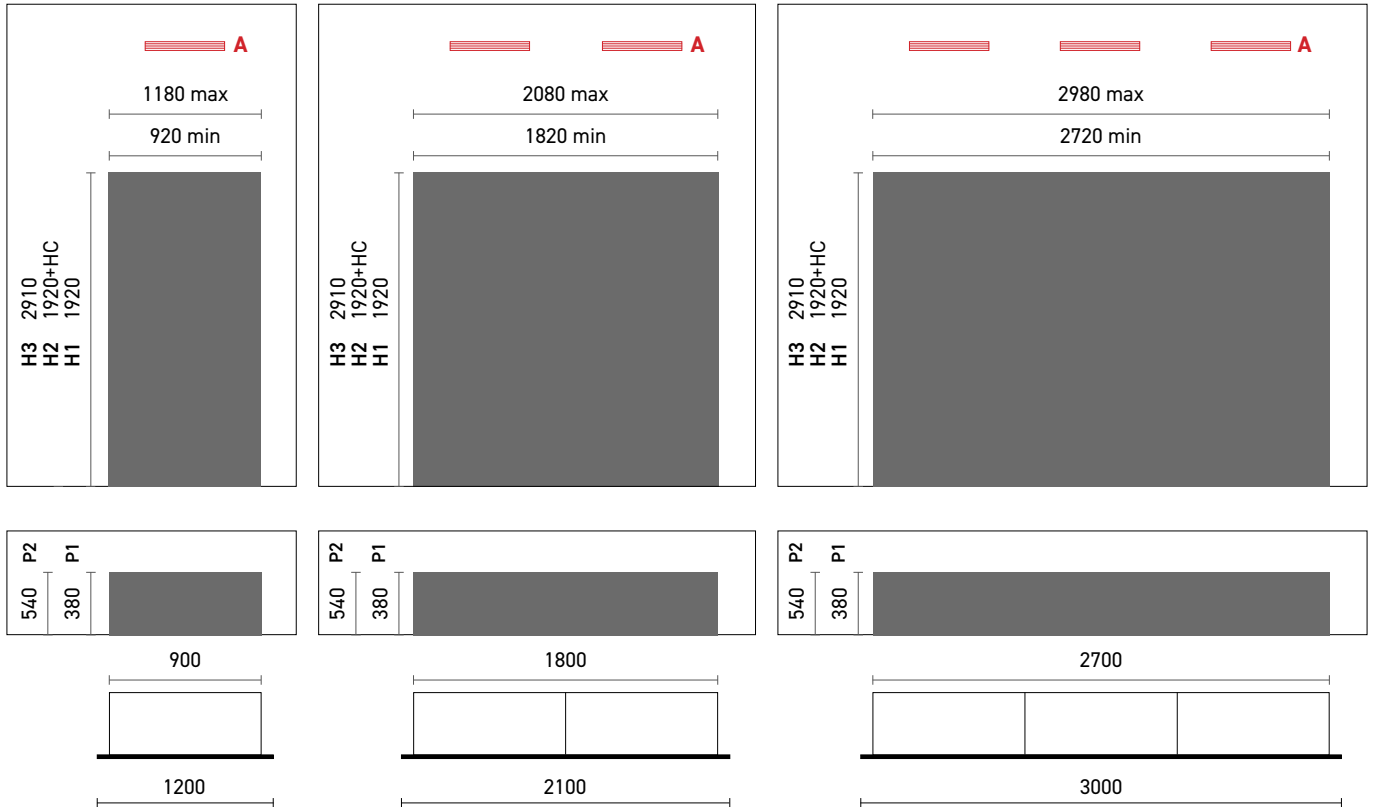

(P1) PH-* • (P2) PM-* • PC-* • (H1) A • (H2) A + C • (H3) A + B

HC (altezze del cavalletto disponibili) • HC (available stand height): mm 150 - 200 - 250 - 300 - 350 - 400 - 450

A Prevedere nella parte alta della parete dove viene incassata la vetrina un'apertura di minimo 160 cm² che consenta la fuoriuscita dell'aria calda (solo PH).

A Include an opening of minimum 160 cm² above the niche where the cabinet is built in to allow discharge of warm air (PH only).

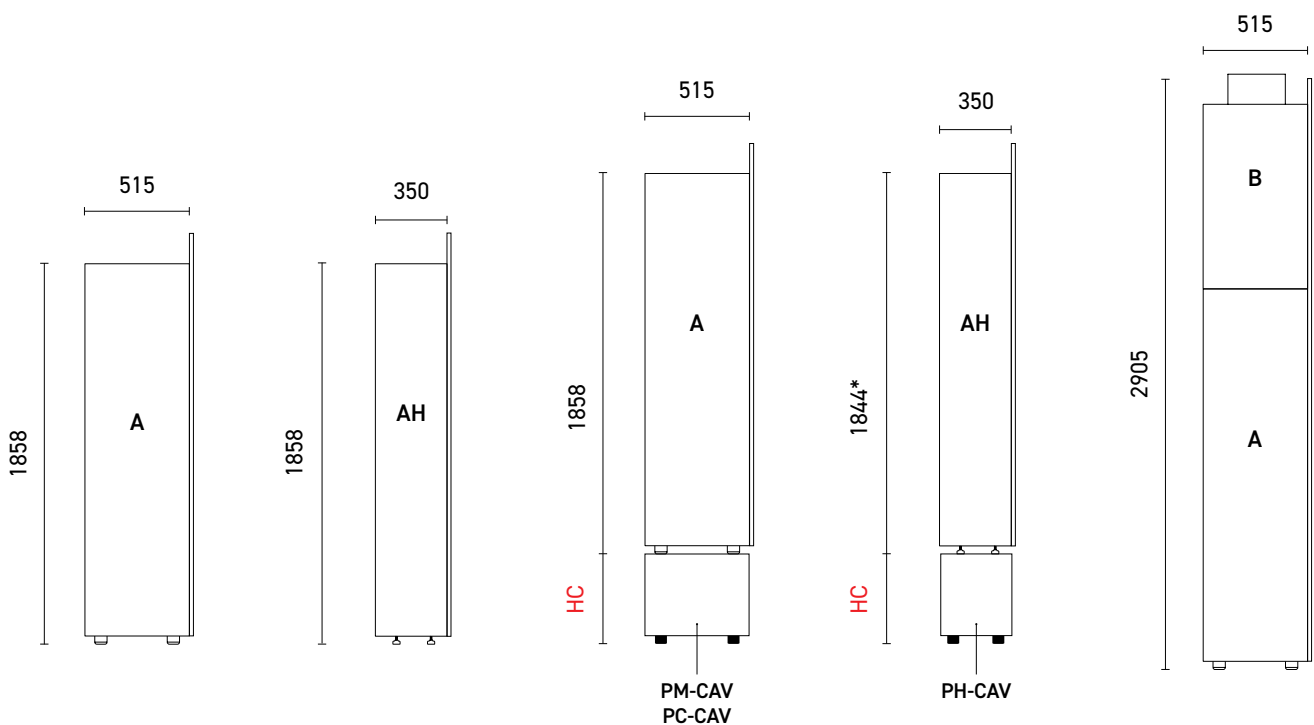

* Quota con piedini chiusi

Cavalletto

Stand

Con l'installazione ad incasso su cavalletto si ottiene uno straordinario effetto scenografico nel quale sia la vetrina che le bottiglie acquistano maggiore visibilità. Il cavalletto è singolo ed è provvisto di piedi regolabili e deflettore di aria calda (PM-PC). Il pannello in medium density è costruito in tre diverse misure per uno, due e tre moduli.

Il cavalletto ha un'altezza standard di 450 mm ma a richiesta può essere fornito anche con altezza 150 - 200 - 250 - 300 - 350 e 400 mm ed è rifinito con l'applicazione di un pannello in medium density magnetico.

The built-in installation on stands makes for a stunning visual effect making both the showcase and the bottles acquire greater visibility. The stand is for a single module and is provided with adjustable feet and warm air deflector (PM-PC). The medium density panel is made in three different sizes to fit one, two or three modules.

The stand has a standard height of 450 mm but upon request it can be supplied with a height of 150 - 200 - 250 - 300 - 350 and 400 mm and finished with the application of a magnetic medium density panel.



Cavalletto in alluminio
Aluminium stand

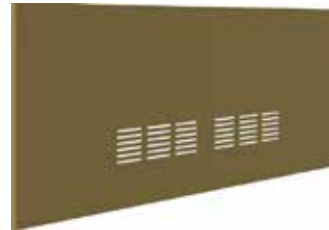

Pannello MDF
MDF panel

CODE		DS
Cavalletto in alluminio - Aluminium stand		
PH-CAV	840 x 350 x HC (150/450)	Per installazione da appoggio e incasso (H) · For built-in and wall-back installation (H)
PM-CAV	780 x 443 x HC (150/450)	Per installazione da appoggio e incasso (M) · For built-in and wall-back installation (M)
PC-CAV	780 x 482 x HC (150/450)	Per installazione centrale (C) For central installation (C)
Pannello (MDF non verniciato - 10 mm) - Panel (unfinished MDF - 10 mm)		
Per installazione ad incasso - For built-in installation		
P-CAV-IN1	1098 x (160/460)	1 modulo - 1 module
P-CAV-IN2	1998 x (160/460)	2 moduli - 2 modules
P-CAV-IN3	2898 x (160/460)	3 moduli - 3 modules
PH-CAV-IN1	1098 x (160/460)	1 modulo - 1 module
PH-CAV-IN2	1998 x (160/460)	2 moduli - 2 modules
PH-CAV-IN3	2898 x (160/460)	3 moduli - 3 modules
Per installazione da appoggio o centrale - For central and wall-back installation		
P-CAV-AC1	1186 x (160/460)	1 modulo - 1 module
P-CAV-AC2	2086 x (160/460)	2 moduli - 2 modules
P-CAV-AC3	2986 x (160/460)	3 moduli - 3 modules
PH-CAV-A1	1186 x (160/460)	1 modulo - 1 module
PH-CAV-A2	2086 x (160/460)	2 moduli - 2 modules
PH-CAV-A3	2986 x (160/460)	3 moduli - 3 modules

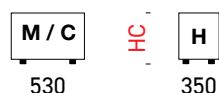

HC (altezze del cavalletto disponibili)
HC (available stand height)
mm 150 - 200 - 250 - 300 - 350 - 400 - 450

Moduli doppi (D / D)

Double units



P* - VDR20



P* - VDR22



P* - VDR23



P* - VDR24



P* - MD10



P* - MD20



P* - MD30



P* - SDR20



P* - GDR20



P* - CDR20

I moduli doppi (D/D) sono composti da 2 moduli "D" singoli e vengono forniti già assemblati insieme (mm 900x510x1898). Occorre scegliere ed indicare il posizionamento dei moduli (superiore ed inferiore). Le caratteristiche tecniche dei singoli moduli sono riportate da pagina 142. Ogni modulo ha il proprio compressore ed il proprio termoregolatore.

The double units (D/D) consist of 2 "D" units supplied already assembled (900x510x1898 mm). Position of the units (top and bottom) must be specified. The specifications of each unit are shown on page 142. Each unit has its own compressor and controller.

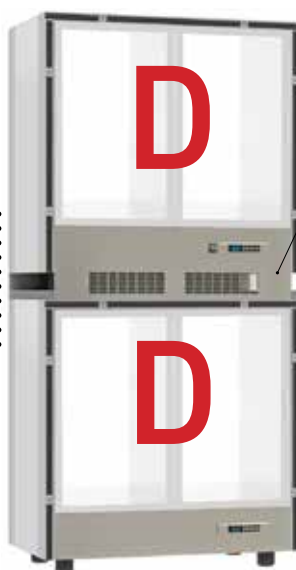

P-AMDD

Alcuni esempi · Some examples



Ⓒ La cover tra una vetrina e l'altra è in lamiera zincata verniciata in colore RAL 9007.

The cover between the two units is made of galvanized steel in RAL 9007 finish.

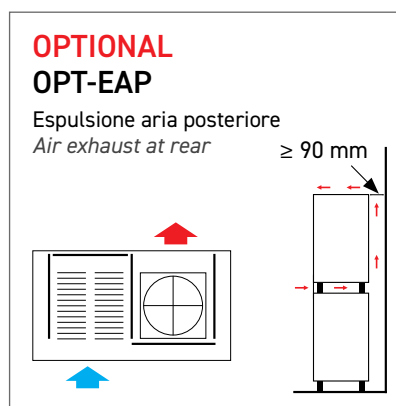

Accessori per moduli senza cornice

Accessories for installation without frame

Le fascette metalliche sono incluse nel codice della cornice e sono dello stesso colore della cornice stessa. Se la cornice non è verniciata le fascette vengono fornite in lamiera zincata non verniciata.

Nei moduli senza cornice, bande magnetiche, fascette metalliche e sportello non sono inclusi.

The metal joint strip covers are already included in the frame code and finished in the same colour as the frame. If the frame is required in raw wood, the metal parts are delivered in unfinished galvanized steel. If the frame is not supplied, the metal strips and the lower flap are not included.

Banda magnetica

magnetic strip

La banda magnetica viene applicata sulla struttura della vetrina e consente l'applicazione delle fascette metalliche.

The magnetic strip is attached to the structure of the cabinet and allows the adhesion of the metal joints

CODE	DS
P-BMA	Banda magnetica 1 modulo A (singolo lato) · <i>Magnetic strip 1 A module (single side)</i>
P-BMB	Banda magnetica 1 modulo B (singolo lato) · <i>Magnetic strip 1 B module (single side)</i>
P-BMD	Banda magnetica 1 modulo D (singolo lato) · <i>Magnetic strip 1 D module (single side)</i>

Fascette metalliche

metal strips

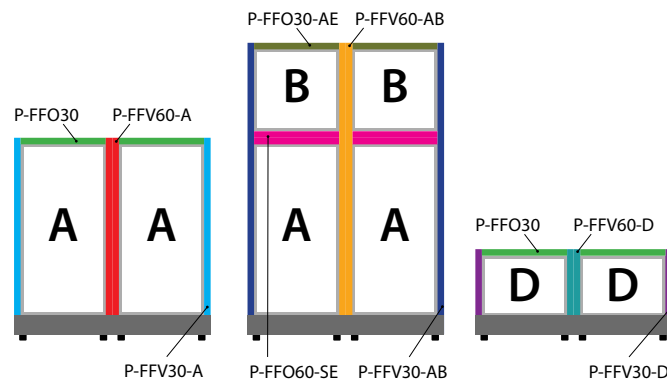

CODE	DS
P-FFO30	Fascetta orizzontale superiore mod. A-D · <i>Upper horizontal strip A-D mod.</i>
P-FFO30-AE	Fascetta orizzontale superiore mod. B · <i>Upper horizontal strip B mod.</i>
P-FFO60-SE	Fascetta orizzontale inferiore mod. B · <i>Lower horizontal strip B mod.</i>
P-FFV30-A	Fascetta verticale laterale mod. A · <i>Side vertical strip A mod.</i>
P-FFV30-AB	Fascetta verticale laterale mod. AB · <i>Side vertical strip AB mod.</i>
P-FFV30-D	Fascetta verticale laterale mod. D · <i>Side vertical strip D mod.</i>
P-FFV60-A	Fascetta verticale centrale mod. A · <i>Middle vertical strip A mod.</i>
P-FFV60-AB	Fascetta verticale centrale mod. AB · <i>Middle vertical strip AB mod.</i>
P-FFV60-D	Fascetta verticale centrale mod. D · <i>Middle vertical strip D mod.</i>

Sportello inferiore

lower flap



Lo sportello inferiore è apribile e consente di accedere al termoregolatore ed alla serratura delle porte. Inclusa ferramenta.

The lower flap opens down and allows access to the controller and the door locks. Supplied with its fittings.

CODE	DS
FN-SL	Sportello lineare Mod SENZA finestra termoregolatore · <i>Linear Mod flap WITHOUT temperature display window</i>
FN-SLF	Sportello lineare Mod CON finestra termoregolatore · <i>Linear Mod flap WITH temperature display window</i>
FN-SS	Sportello sagomato Mod SENZA finestra termoregolatore · <i>Moulded Mod flap WITHOUT temperature display window</i>
FN-SSF	Sportello sagomato Mod CON finestra termoregolatore · <i>Moulded Mod flap WITH temperature display window</i>

Nota bene

Gli sportelli, nel caso di cornici e rivestimenti FIT sono di default SENZA finestra, è possibile richiedere la finestra inserendo i seguenti OPT.

Logicamente il costo dell'OPT è basso in quanto si tratta di una semplice sostituzione dello sportello senza finestra con lo sportello con finestra.

N.B.

Lower flaps, in case of frames and FIT cladding, are by default WITHOUT window - window can be requested by adding the following OPT.

Cost for the OPT is low as this is a simple replacement of the flap without window with a flap with window.

Optional finestra

CODE	DS
OPT-SLF	Optional sportello lineare Mod con Finestra · <i>Linear Mod flap option with Window</i>
OPT-SSF	Optional sportello sagomato Mod con Finestra · <i>Moulded Mod flap option with Window</i>

Pannello superiore

Top panel



Pannello di rifinitura parte superiore da inserire nel caso in cui la composizione sia visibile da una scala o da un piano superiore.

Top finishing panel to add where the top of the composition is visible from stairs or upper floors.

CODE	DS
P-PS1	Pannello superiore per 1 modulo - 1183x510x5 mm · <i>Top panel for 1 module - 1183x510x5 mm</i>
P-PS2	Pannello superiore per 2 moduli - 2083x510x5 mm · <i>Top panel for 2 modules - 2083x510x5 mm</i>
P-PS3	Pannello superiore per 3 moduli - 2983x510x5 mm · <i>Top panel for 3 modules - 2983x510x5 mm</i>

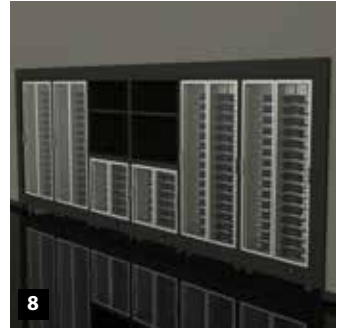
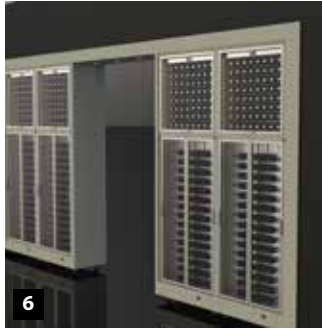

Example setups



21



22



23



24



25



26



27



28



29



30



31



32



33



34



35



36



37



38















39



40

Mod



CODE	mm LxPxH		N. 0,75 LT	H	Class	P _{nom} ↓ W	INV	HF	LIGHT	dB
	mm LxPxH							HF		
 PH-VAR10	900 x 363 x 1858		60	278	SN-N	120	INV	R 600 a	NW	42
	1000 x 800 x 2060		H 360 ∅ 93		230 50-60Hz			52		
 PM-VAR10	900 x 515 x 1858		120	545	SN-N	320	FIX	R 290	NW	47
	1000 x 800 x 2060		H 360 ∅ 90		230 / 50Hz			95		
 PC-VAR10	900 x 520 x 1858		120	557	SN-N	320	FIX	R 290	NW	47
	1000 x 800 x 2060		H 360 ∅ 90		230 / 50Hz			95		
 PM-VAR12	900 x 515 x 1858		112	545	SN-N	320	FIX	R 290	NW	47
	1000 x 800 x 2060		H 350 ∅ 95		230 / 50Hz			95		
 PC-VAR12	900 x 520 x 1858		112	557	SN-N	320	FIX	R 290	NW	47
	1000 x 800 x 2060		H 350 ∅ 95		230 / 50Hz			95		
 PM-VAR13	900 x 515 x 1858		128	545	SN-N	320	FIX	R 290	NW	47
	1000 x 800 x 2060		-		230 / 50Hz			95		
 PC-VAR13	900 x 520 x 1858		128	557	SN-N	320	FIX	R 290	NW	47
	1000 x 800 x 2060		-		230 / 50Hz			95		

			
		OFF	ON

97	1,7				
117					
107	1,7	+16 °C	+20 °C	+8 °C	+16 °C
132		+12 °C	+18 °C	+4 °C	+14 °C
		SET 4 °C	SET 14 °C	SET 4 °C	SET 14 °C
120	1,7				
145					
107	1,7	+14 °C	+20 °C	+8 °C	+16 °C
132		+12 °C	+18 °C	+4 °C	+14 °C
		SET 4 °C	SET 14 °C	SET 4 °C	SET 14 °C
141	1,7				
166					
117	1,7	+14 °C	+20 °C	+8 °C	+16 °C
142		+12 °C	+18 °C	+4 °C	+14 °C
		SET 4 °C	SET 14 °C	SET 4 °C	SET 14 °C
151	1,7				
176					

Le temperature riportate sono indicative e possono variare di (+ -) 2 °C. Rilevazioni effettuate con temperatura ambiente di 25 °C.
 Reported temperatures are approximate and may vary by (+ -) 2 °C. Detections made in 25 °C ambient temperature.

Mod



CODE	mm LxPxH		N. 0,75 LT	H ∅	Class ⚡	P _{nom} W	INV	HF	LIGHT	dB
	mm LxPxH							HF		
 PH-VAR14 ^S	900 x 363 x 1858		OPT14	278	SN-N	320	INV	R 600 a	NW	42
	1000 x 800 x 2060				230 / 50-60Hz			52		
 PM-VAR14 ^S	900 x 515 x 1858		OPT14	545	SN-N	320	FIX	R 290	NW	47
	1000 x 800 x 2060				230 / 50Hz			95		
 PC-VAR14 ^S	900 x 520 x 1858		OPT14	557	SN-N	320	FIX	R 290	NW	47
	1000 x 800 x 2060				230 / 50Hz			95		





S. Senza allestimento interno • Without inside fittings

OPT14 - Pag. 128



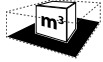

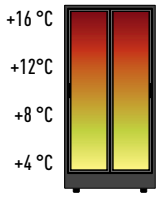
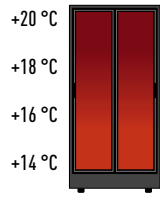
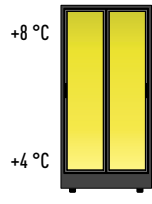
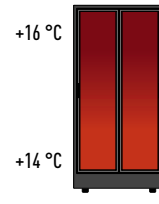
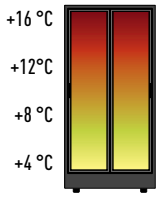
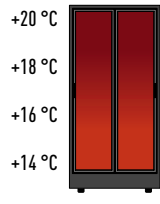
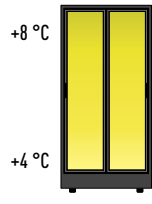
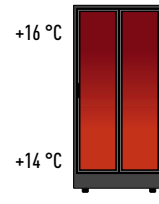
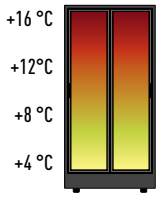
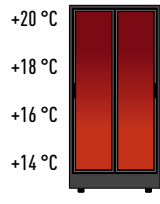
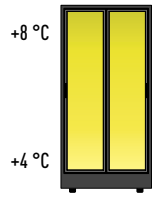
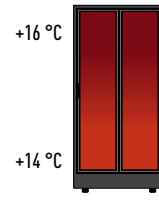

Mod

CODE	mm LxPxH		N. 0,75 LT	H ∅	Class ⚡	P _{nom} W	INV	HF	LIGHT	dB
	mm LxPxH							HF		
 PM-SAR10	900 x 515 x 1858		4	545	SN-N	320	FIX	R 290	NW	47
	1000 x 800 x 2060				230 / 50Hz			95		
 PC-SAR10	900 x 520 x 1858		4	557	SN-N	320	FIX	R 290	NW	47
	1000 x 800 x 2060				230 / 50Hz			95		

			
		OFF	ON





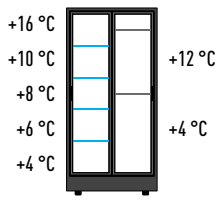
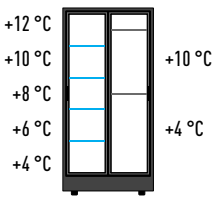
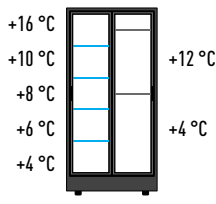
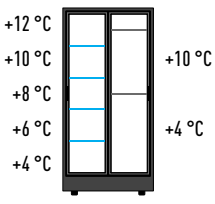





97	1,7	 	 
117			
103	1,7	 	 
128			
116	1,7	 	 
141			

			
		OFF	ON







107	1,7		
132			
141	1,7		
169			

Le temperature riportate sono indicative e possono variare di (+ -) 2 °C. Rilevazioni effettuate con temperatura ambiente di 25 °C.
 Reported temperatures are approximate and may vary by (+ -) 2 °C. Detections made in 25 °C ambient temperature.







Mod





CODE	 mm LxPxH				Class			HF		
	 mm LxPxH									

MODULI GASTRONOMIA (A) • Delicatessen modules

	PH-GAR10	900 x 363 x 1858		8	278	SN-N	120	INV	R 600 a	NW	42
		1000 x 800 x 2060		-		230 50-60Hz			52		
	PM-GAR10	900 x 515 x 1858		8	545	SN-N	320	FIX	R 290	NW	47
		1000 x 800 x 2060		-		230 / 50Hz			95		
	PC-GAR10	900 x 520 x 1858		8	557	SN-N	320	FIX	R 290	NW	47
		1000 x 800 x 2060		-		230 / 50Hz			95		

MODULI CIOCCOLATO (A) • Chocolate modules

	PH-CAR10	900 x 363 x 1858		14	278	SN-N	120	INV	R 600 a	CCT	42
		1000 x 800 x 2060		-		230 50-60Hz			52		
	PM-CAR10	900 x 515 x 1858		14	545	SN-N	320	FIX	R 290	CCT	47
		1000 x 800 x 2060		-		230 / 50Hz			95		
	PC-CAR10	900 x 520 x 1858		14	557	SN-N	320	FIX	R 290	CCT	47
		1000 x 800 x 2060		-		230 / 50Hz			95		



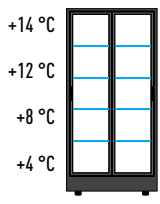
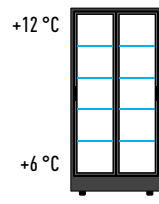

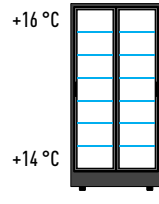











 		 OFF	 ON
---	---	--	---

97	1,7	 <p>SET 4 °C</p>	 <p>SET 6 °C</p>
117			
107	1,7		
132			
151	1,7		
176			

97	1,7	-	 <p>SET 14 °C</p> <p>🌧️ % RH < 45%</p>
117			
125	1,7		
150			
159	1,7		
184			







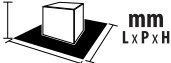

Le temperature riportate sono indicative e possono variare di (+ -) 2 °C. Rilevazioni effettuate con temperatura ambiente di 25 °C.
 Reported temperatures are approximate and may vary by (+ -) 2 °C. Detections made in 25 °C ambient temperature.

Mod













CODE	 M01	 RAL*		 mm L x P x H
 PH-MA10	•	•	≡	900 x 363 x 1858
 PM-MA10	•	•	≡	900 x 515 x 1858
 PC-MA10	•	•	≡	900 x 520 x 1858
 PH-MA20	•	•	≡	900 x 363 x 1858
 PM-MA20	•	•	≡	900 x 515 x 1858
 PC-MA20	•	•	≡	900 x 520 x 1858
 PH-MA30	-	-	≡	900 x 363 x 1858
 PM-MA30	-	-	≡	900 x 515 x 1858
 PC-MA30	-	-	≡	900 x 520 x 1858
 PH-MA40	-	-	≡	486 x 363 x 1858
 PM-MA40	-	-	≡	486 x 515 x 1858
 PC-MA40	-	-	≡	486 x 520 x 1858

* I colori RAL vengono realizzati su supporto di MDF in finitura opaca 20 gloss.









* RAL colours are made in MDF 20-gloss matte finish.

									
1000 x 800 x 2070	■	-	-	-	-	-	88	113	1,7
1000 x 800 x 2070	■	-	-	-	-	-	98	123	1,7
1000 x 800 x 2070	□	-	-	-	-	-	96	121	1,7
1000 x 800 x 2070	■	-	-	-	-	-	72	97	1,7
1000 x 800 x 2070	■	-	-	-	-	-	82	107	1,7
1000 x 800 x 2070	□	-	-	-	-	-	80	105	1,7
1000 x 800 x 2070	■	NW	-	100 - 240V	16	95	120	1,7	
1000 x 800 x 2070	■	NW	-	100 - 240V	32	105	130	1,7	
1000 x 800 x 2070	□	NW	-	100 - 240V	32	127	152	1,7	
600 x 800 x 2070	■	NW	-	100 - 240V	16	45	58	0,9	
600 x 800 x 2070	■	NW	-	100 - 240V	32	55	68	0,9	
600 x 800 x 2070	□	NW	-	100 - 240V	32	72	85	0,9	























Mod

CODE	 mm LxPxH		 N. 0,75 LT		Class 	P _{nom}  W		 HF	 LIGHT	 dB
	 mm LxPxH		 H Ø					 HF		

MODULI REFRIGERATI PER VINO (B) • Wine cooling units





	PM-VBR10	900 x 515 x 1050		64	202	SN-N	120	INV	R 600 a	NW	45
		1000 x 800 x 1220		H 370 Ø 80		230 / 50Hz			25		
	PC-VBR10	900 x 520 x 1050		64	271	SN-N	120	INV	R 600 a	NW	45
		1000 x 800 x 1220		H 370 Ø 80		230 / 50Hz			25		
	PM-VBR13	900 x 515 x 1050		80	202	SN-N	120	INV	R 600 a	NW	45
		1000 x 800 x 1220		H 370 -		230 / 50Hz			25		
	PC-VBR13	900 x 520 x 1050		80	271	SN-N	120	INV	R 600 a	NW	45
		1000 x 800 x 1220		H 370 -		230 / 50Hz			25		

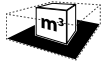

MODULI NEUTRI (B) • Neutral modules

CODE	 M01	 RAL*		 mm LxPxH	 mm LxPxH
	PH-MB30	-		900 x 363 x 900	1000 x 800 x 1120
	PM-MB30	-		900 x 515 x 900	1000 x 800 x 1120
	PC-MB30	-		900 x 520 x 900	1000 x 800 x 1120
	PH-MB40	-		486 x 363 x 900	600 x 800 x 1120
	PM-MB40	-		486 x 515 x 900	600 x 800 x 1120
	PC-MB40	-		486 x 520 x 900	600 x 800 x 1120
	PH-MB20	•		900 x 363 x 900	1000 x 800 x 1120
	PM-MB20	•		900 x 515 x 900	1000 x 800 x 1120
	PC-MB20	•		900 x 520 x 900	1000 x 800 x 1120





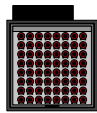













* I colori RAL vengono realizzati su supporto di MDF in finitura opaca 20 gloss.

* RAL colours are made in MDF 20-gloss matte finish.









			
		OFF	ON

67	1	-	
88			
83	1	-	SET 14 °C
104			
65	1	-	
86			
81	1	-	SET 14 °C
102			

Le temperature riportate sono indicative e possono variare di (+ -) 2 °C. Rilevazioni effettuate con temperatura ambiente di 25 °C.
 Reported temperatures are approximate and may vary by (+ -) 2 °C. Detections made in 25 °C ambient temperature.





								
	-	NW	-	100 - 240V	8	50	71	1
	-	NW	-	100 - 240V	8	55	76	1
	-	NW	-	100 - 240V	16	73	94	1
	-	NW	-	100 - 240V	8	30	41	0,6
	-	NW	-	100 - 240V	8	35	46	0,6
	-	NW	-	100 - 240V	16	53	64	0,6
	-	-	-	-	-	42	53	1
	-	-	-	-	-	47	58	1
	-	-	-	-	-	49	60	1

Mod

CODE	mm LxPxH		N. 0,75 LT	H	Class	P _{nom} W	INV	HF	LIGHT	dB
	mm LxPxH							HF		
 PH-VDR20	900 x 363 x 903		24	113	SN-N	120	INV	R 600 a	NW	38
	1000 x 800 x 1120		H 360 Ø 93		230 50-60Hz			25		
 PM-VDR20	900 x 515 x 903		48	222	SN-N	120	INV	R 600 a	NW	45
	1000 x 800 x 1120		H 360 Ø 90		230 50-60Hz			55		
 PC-VDR20	900 x 520 x 903		48	227	SN-N	120	INV	R 600 a	NW	45
	1000 x 800 x 1120		H 360 Ø 90		230 50-60Hz			55		
 PM-VDR22	900 x 515 x 903		42	222	SN-N	120	INV	R 600 a	NW	45
	1000 x 800 x 1120		H 350 Ø 95		230 50-60Hz			55		
 PC-VDR22	900 x 520 x 903		42	227	SN-N	120	INV	R 600 a	NW	45
	1000 x 800 x 1120		H 350 Ø 95		230 50-60Hz			55		
 PM-VDR23	900 x 515 x 903		64	222	SN-N	120	INV	R 600 a	NW	45
	1000 x 800 x 1120		-		230 50-60Hz			55		
 PC-VDR23	900 x 520 x 903		64	227	SN-N	120	INV	R 600 a	NW	45
	1000 x 800 x 1120		-		230 50-60Hz			55		
 PH-VDR24 _s	900 x 363 x 903		OPT14	113	SN-N	120	INV	R 600 a	NW	38
	1000 x 800 x 1120				230 50-60Hz			25		
 PM-VDR24 _s	900 x 515 x 903		OPT14	222	SN-N	120	INV	R 600 a	NW	45
	1000 x 800 x 1120				230 50-60Hz			55		
 PC-VDR24 _s	900 x 520 x 903		OPT14	227	SN-N	120	INV	R 600 a	NW	45
	1000 x 800 x 1120				230 50-60Hz			55		

S. Senza allestimento interno • Without inside fittings

OPT14 - Pag. 128 











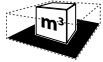

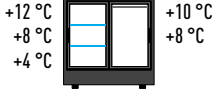

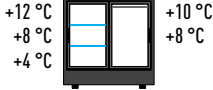
			
		OFF	ON

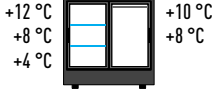
59	0,9				
77					
69	0,9	+12 °C +8 °C +4 °C	+20 °C +14 °C	+6 °C +4 °C	+16 °C +14 °C
90		SET 4 °C	SET 14 °C	SET 4 °C	SET 14 °C
79	0,9				
100					
69	0,9	+12 °C +6 °C +4 °C	+20 °C +14 °C	+6 °C +4 °C	+16 °C +14 °C
90		SET 4 °C	SET 14 °C	SET 4 °C	SET 14 °C
79	0,9				
100					
71	0,9	+12 °C +6 °C +4 °C	+20 °C +14 °C	+6 °C +4 °C	+16 °C +14 °C
92		SET 4 °C	SET 14 °C	SET 4 °C	SET 14 °C
81	0,9				
102					
59	0,9				
77					
66	0,9	+12 °C +8 °C +4 °C	+20 °C +14 °C	+6 °C +4 °C	+16 °C +14 °C
97		SET 4 °C	SET 14 °C	SET 4 °C	SET 14 °C
76	0,9				
107					

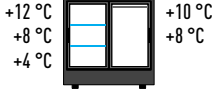
Le temperature riportate sono indicative e possono variare di (+ -) 2 °C. Rilevazioni effettuate con temperatura ambiente di 25 °C.
 Reported temperatures are approximate and may vary by (+ -) 2 °C. Detections made in 25 °C ambient temperature.

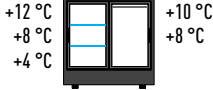









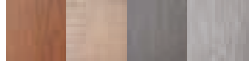





Mod

CODE	mm LxPxH					Class	P _{nom} ↓ W		HF			dB
	mm LxPxH								HF			
MODULI SALUMERIA (D) • Salami modules												
	900 x 515 x 903		2	222	SN-N	120	INV	R 600 a	NW	45		
	1000 x 800 x 1120		1		230 50-60Hz			55				
	900 x 520 x 903		2	227	SN-N	120	INV	R 600 a	NW	45		
	1000 x 800 x 1120		1		230 50-60Hz			55				
MODULI GASTRONOMIA (D) • Delicatessen modules												
	900 x 363 x 903		4	113	SN-N	120	INV	R 600 a	NW	38		
	1000 x 800 x 1120		-		230 50-60Hz			25				
	900 x 515 x 903		4	222	SN-N	120	INV	R 600 a	NW	45		
	1000 x 800 x 1120		-		230 50-60Hz			55				
	900 x 520 x 903		4	227	SN-N	120	INV	R 600 a	NW	45		
	1000 x 800 x 1120		-		230 50-60Hz			55				
MODULI CIOCCOLATO (D) • Chocolate modules												
	900 x 363 x 903		4	113	SN-N	120	INV	R 600 a	CCT	38		
	1000 x 800 x 1120		-		230 50-60Hz			25				
	900 x 515 x 903		4	222	SN-N	120	INV	R 600 a	CCT	45		
	1000 x 800 x 1120		-		230 50-60Hz			55				
	900 x 520 x 903		4	227	SN-N	120	INV	R 600 a	CCT	45		
	1000 x 800 x 1120		-		230 50-60Hz			55				

 		 OFF	 ON
69	0,9	 SET 4 °C	 SET 4 °C
90			
79	0,9	 SET 4 °C	 SET 4 °C
100			
62	0,9	 SET 4 °C	 SET 4 °C
80			
71	0,9	 SET 4 °C	 SET 4 °C
92			
81	0,9	 SET 4 °C	 SET 4 °C
102			
63	0,9	-	 %RH < 45% SET 14 °C
81			
67	0,9	-	 %RH < 45% SET 14 °C
90			
81	0,9	-	 %RH < 45% SET 14 °C
102			

Le temperature riportate sono indicative e possono variare di (+ -) 2 °C. Rilevazioni effettuate con temperatura ambiente di 25 °C.
 Reported temperatures are approximate and may vary by (+ -) 2 °C. Detections made in 25 °C ambient temperature.

Mod

CODE														 RAL *	
	M01	L20	L21	L22	L23	L10	L11	L30	L40	L42	L50	L51	L52		L53
MODULI NEUTRI (D) • Neutral modules															
	PH-MD10	•		•						•					•
	PM-MD10	•		•						•					•
	PC-MD10	•		•						•					•
	PH-MD20	•		-						-					•
	PM-MD20	•		-						-					•
	PC-MD20	•		-						-					•
	PH-MD30	•		-						-					-
	PM-MD30	•		-						-					-
	PC-MD30	•		-						-					-
	PH-MD40	•		-						-					-
	PM-MD40	•		-						-					-
	PC-MD40	•		-						-					-
CAVALLETTO															
	PH-CAV	•		-						-					-
	PM-CAV	•		-						-					-
	PC-CAV	•		-						-					-
	PH-CAV-IN1	•		-						-					•
	PH-CAV-IN2	•		-						-					•
	PH-CAV-IN3	•		-						-					•
	P-CAV-IN1	•		-						-					•
	P-CAV-IN2	•		-						-					•
	P-CAV-IN3	•		-						-					•
	PH-CAV-A1	•		-						-					•
	PH-CAV-A2	•		-						-					•
	PH-CAV-A3	•		-						-					•
	P-CAV-AC1	•		-						-					•
	P-CAV-AC2	•		-						-					•
	P-CAV-AC3	•		-						-					•

* I colori RAL vengono realizzati su supporto di MDF o HPL in finitura opaca 20 gloss.

* RAL colours are made in MDF or HPL 20-gloss matte finish.

					
---	---	---	---	---	---

-	900 x 363 x 903	1000 x 800 x 1120	59	72	0,9
-	900 x 515 x 903	1000 x 800 x 1120	67	80	0,9
-	900 x 520 x 903	1000 x 800 x 1120	65	78	0,9
-	900 x 363 x 903	1000 x 800 x 1120	54	75	0,9
-	900 x 515 x 903	1000 x 800 x 1120	62	83	0,9
-	900 x 520 x 903	1000 x 800 x 1120	52	73	0,9
NW	900 x 363 x 903	1000 x 800 x 1120	53	74	0,9
NW	900 x 515 x 903	1000 x 800 x 1120	61	82	0,9
NW	900 x 520 x 903	1000 x 800 x 1120	71	92	0,9
NW	486 x 363 x 903	600 x 800 x 1120	28	49	0,6
NW	486 x 515 x 903	600 x 800 x 1120	32	53	0,6
NW	486 x 520 x 903	600 x 800 x 1120	37	58	0,6

-	840 x 350 x HC (150/450)	-	-	-	-
-	780 x 443 x HC (150/450)	-	-	-	-
-	780 x 482 x HC (150/450)	-	-	-	-
-	1098 x (160/460)	-	-	-	-
-	1998 x (160/460)	-	-	-	-
-	2898 x (160/460)	-	-	-	-
-	1098 x (210/510)	-	-	-	-
-	1998 x (210/510)	-	-	-	-
-	2898 x (210/510)	-	-	-	-
-	1186 x (160/460)	-	-	-	-
-	2086 x (160/460)	-	-	-	-
-	2986 x (160/460)	-	-	-	-
-	1186 x (210/510)	-	-	-	-
-	2086 x (210/510)	-	-	-	-
-	2986 x (210/510)	-	-	-	-

Finiture Mod

CODE



L01



A01



M01

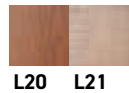

L20 L21

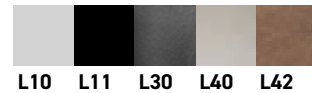

L10 L11 L30 L40 L42



L22 L23

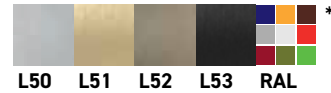

L50 L51 L52 L53 RAL



LM01 LM02

CORNICI (A) · FRAMES

	FN-CL1A	•	-	-	•	•	•
	FN-CL2A	•	-	-	•	•	•
	FN-CL3A	•	-	-	•	•	•
	FN-CL4A	•	-	-	•	•	•
	FN-CL5A	•	-	-	•	•	•
	FN-CL6A	•	-	-	•	•	•
	FN-CS1A	-	•	-	-	-	•
	FN-CS2A	-	•	-	-	-	•
	FN-CS3A	-	•	-	-	-	•
	FN-CS4A	-	•	-	-	-	•
	FN-CS5A	-	•	-	-	-	•
	FN-CS6A	-	•	-	-	-	•

PANNELLI LATERALI (A) · SIDES PANELS

	FN-PLHA	•	-	-	•	•	•
	FN-PLA	•	-	-	•	•	•

PANNELLI LATERALI (AC) · SIDES PANELS









	FN-PLHAC	•	-	-	•	•	•
	FN-PLAC	•	-	-	•	•	•

RIVESTIMENTO FIT (A) · Fit cladding

	FN-RFH1A	•	-	-	•	•	•
	FN-RFM1A	•	-	-	•	•	•
	FN-RFC1A	•	-	-	•	•	•
	FN-RFH2A	•	-	-	•	•	•
	FN-RFM2A	•	-	-	•	•	•
	FN-RFC2A	•	-	-	•	•	•
	FN-RFH3A	•	-	-	•	•	•
	FN-RFM3A	•	-	-	•	•	•
	FN-RFC3A	•	-	-	•	•	•

* I colori RAL vengono realizzati su supporto di MDF o HPL in finitura opaca 20 gloss.

* RAL colours are made in MDF or HPL 20-gloss matte finish.

								
---	---	---	---	---	--	---	---	---

1968 x 1200 x 7	2250 x 600 x 100	2250 x 600 x 250	•	14	26	34	0,2	0,4
1968 x 2100 x 7	2250 x 600 x 100	2250 x 600 x 250	•	17	29	37	0,2	0,4
1968 x 3000 x 7	3120 x 600 x 100	3120 x 600 x 250	•	21	36	44	0,2	0,5
1968 x 3900 x 7	3120 x 600 x 100	3120 x 600 x 250	•	25	40	48	0,2	0,5
1968 x 4800 x 7	3120 x 600 x 100	3120 x 600 x 250	•	29	44	52	0,2	0,5
1968 x 5700 x 7	3120 x 600 x 200	3120 x 600 x 350	•	33	63	71	0,4	0,7
1968 x 1200 x 70	2250 x 600 x 150	2250 x 600 x 300	•	13	31	39	0,2	0,4
1968 x 2100 x 70	2250 x 600 x 150	2250 x 600 x 300	•	16	34	42	0,2	0,4
1968 x 3000 x 70	3120 x 600 x 150	3120 x 600 x 300	•	19	42	50	0,3	0,6
1968 x 3900 x 70	3120 x 600 x 150	3120 x 600 x 300	•	23	46	54	0,3	0,6
1968 x 4800 x 70	3120 x 600 x 150	3120 x 600 x 300	•	26	49	57	0,3	0,6
1968 x 5700 x 70	3120 x 600 x 300	3120 x 600 x 450	•	30	45	83	0,6	0,9

1968 x 350 x 5	-	-	-	-	-	-	-	-
1968 x 510 x 5	-	-	-	-	-	-	-	-

2478 + HC x 350 x 5	-	-	-	-	-	-	-	-
1968 + HC x 510 x 5	-	-	-	-	-	-	-	-

-	-	-	-	23	-	-	-	-
-	-	-	-	28	-	-	-	-
-	-	-	-	30	-	-	-	-
-	-	-	-	29	-	-	-	-
-	-	-	-	35	-	-	-	-
-	-	-	-	38	-	-	-	-
-	-	-	-	35	-	-	-	-
-	-	-	-	42	-	-	-	-
-	-	-	-	47	-	-	-	-

Con le finiture A01 e L01 le fascette magnetiche sono in metallo non verniciato.
 With A01 and L01, magnetic strips are in unfinished metal.

Finiture Mod

CODE



L01



A01



M01

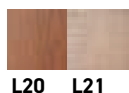

L20

L21



L22

L23



L10

L11

L30

L40

L42



L50

L51

L52

L53

RAL



LM01

LM02

CORNICI (AB) · FRAMES

	FN-CL1AB	•	-	-	•	•	•
	FN-CL2AB	•	-	-	•	•	•
	FN-CL3AB	•	-	-	•	•	•
	FN-CL4AB	•	-	-	•	•	•
	FN-CL5AB	•	-	-	•	•	•
	FN-CL6AB	•	-	-	•	•	•
	FN-CS1AB	-	•	-	-	-	•
	FN-CS2AB	-	•	-	-	-	•
	FN-CS3AB	-	•	-	-	-	•
	FN-CS4AB	-	•	-	-	-	•
	FN-CS5AB	-	•	-	-	-	•
	FN-CS6AB	-	•	-	-	-	•

PANNELLI LATERALI (AB) · SIDES PANELS

	FN-PLHAB	•	-	-	•	•	•
	FN-PLAB	•	-	-	•	•	•

CORNICI (D) · FRAMES · CADRES









	FN-CL1D	•	-	-	•	•	•
	FN-CL2D	•	-	-	•	•	•
	FN-CL3D	•	-	-	•	•	•
	FN-CL4D	•	-	-	•	•	•
	FN-CL5D	•	-	-	•	•	•
	FN-CL6D	•	-	-	•	•	•
	FN-CS1D	-	•	-	-	-	•
	FN-CS2D	-	•	-	-	-	•
	FN-CS3D	-	•	-	-	-	•
	FN-CS4D	-	•	-	-	-	•
	FN-CS5D	-	•	-	-	-	•
	FN-CS6D	-	•	-	-	-	•

RIVESTIMENTO FIT (D) · Fit cladding

	FN-RFH1D	•	-	-	•	•	•
	FN-RFM1D	•	-	-	•	•	•
	FN-RFC1D	•	-	-	•	•	•
	FN-RFH2D	•	-	-	•	•	•
	FN-RFM2D	•	-	-	•	•	•
	FN-RFC2D	•	-	-	•	•	•
	FN-RFH3D	•	-	-	•	•	•
	FN-RFM3D	•	-	-	•	•	•
	FN-RFC3D	•	-	-	•	•	•

* I colori RAL vengono realizzati su supporto di MDF in finitura opaca 20 gloss.

* RAL colours are made in MDF 20-gloss matte finish.

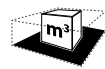
								
---	---	---	---	---	--	---	---	---











2868 x 1200 x 7	3120 x 600 x 100	3120 x 600 x 250	•	18	33	41	0,2	0,5
2868 x 2100 x 7	3120 x 600 x 100	3120 x 600 x 250	•	22	37	45	0,2	0,5
2868 x 3000 x 7	3310 x 600 x 100	3310 x 600 x 250	•	25	41	49	0,2	0,5
2868 x 3900 x 7	3310 x 600 x 100	3310 x 600 x 250	•	29	45	53	0,2	0,5
2868 x 4800 x 7	3310 x 600 x 100	3310 x 600 x 250	•	33	49	57	0,2	0,5
2868 x 5700 x 7	3310 x 600 x 200	3310 x 600 x 350	•	37	69	77	0,4	0,7
2868 x 1200 x 70	3120 x 600 x 150	3120 x 600 x 300	•	16	39	47	0,3	0,6
2868 x 2100 x 70	3120 x 600 x 150	3120 x 600 x 300	•	19	42	50	0,3	0,6
2868 x 3000 x 70	3310 x 600 x 150	3310 x 600 x 300	•	23	47	55	0,3	0,6
2868 x 3900 x 70	3310 x 600 x 150	3310 x 600 x 300	•	26	50	58	0,3	0,6
2868 x 4800 x 70	3310 x 600 x 150	3310 x 600 x 300	•	30	54	62	0,3	0,6
2868 x 5700 x 70	3310 x 600 x 300	3310 x 600 x 450	•	33	81	89	0,6	0,9

2868 x 350 x 5	-	-	-	-	-	-	-	-
2868 x 510 x 5	-	-	-	-	-	-	-	-

1013 X 1200 X 7	1320 X 600 X 100	1320 X 600 X 250	•	10	20	28	0,1	0,2
1013 X 2100 X 7	2250 X 600 X 100	2250 X 600 X 250	•	12	22	30	0,1	0,3
1013 X 3000 X 7	3120 X 600 X 100	3120 X 600 X 250	•	15	25	33	0,1	0,5
1013 X 3900 X 7	3120 X 600 X 100	3120 X 600 X 250	•	18	28	37	0,1	0,5
1013 X 4800 X 7	3120 X 600 X 100	3120 X 600 X 250	•	21	31	41	0,1	0,5
1013 X 5700 X 7	3120 X 600 X 100	3120 X 600 X 250	•	24	34	48	0,1	0,5
1013 X 1200 X 70	1320 X 600 X 150	1320 X 600 X 300	•	11	21	29	0,1	0,2
1013 X 2100 X 70	2250 X 600 X 150	2250 X 600 X 300	•	13	23	31	0,1	0,4
1013 X 3000 X 70	3120 X 600 X 150	3120 X 600 X 300	•	16	26	34	0,1	0,6
1013 X 3900 X 70	3120 X 600 X 150	3120 X 600 X 300	•	19	29	38	0,1	0,6
1013 X 4800 X 70	3120 X 600 X 150	3120 X 600 X 300	•	23	33	41	0,1	0,6
1013 X 5700 X 70	3120 X 600 X 300	3120 X 600 X 450	•	27	37	47	0,1	0,6

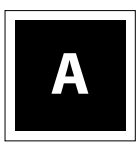
914 x 370 x 909	-	-		15	-	-	-	-
914 x 540 x 910	-	-		18	-	-	-	-
914 x 540 x 910	-	-		20	-	-	-	-
1814 x 370 x 909	-	-		21	-	-	-	-
1814 x 540 x 9150	-	-		25	-	-	-	-
1814 x 540 x 910	-	-		28	-	-	-	-
2714 x 370 x 909	-	-		27	-	-	-	-
2714 x 540 x 910	-	-		32	-	-	-	-
2714 x 540 x 910	-	-		37	-	-	-	-

Optional

CODE	DS	Disponibile <i>Available</i>	Non disponibile <i>Not available</i>
 OPT-TCR	Termoregolatore controllo remoto <i>Temperature control remote access</i>	Tutte le vetrine <i>All units</i>	Moduli B
 OPT-RGB-CX	Controller RGB <i>RGB controller</i>	Tutte le vetrine <i>All units</i>	Moduli B
 OPT-CBD-CX	Controller bianco dinamico <i>Dinamic white controller</i>	Tutte le vetrine <i>All units</i>	Moduli B
 OPT-RGB	Controller RGB <i>RGB controller</i>	Tutte le vetrine <i>All units</i>	-
 OPT-CBD	Controller bianco dinamico <i>Dinamic white controller</i>	Tutte le vetrine <i>All units</i>	-
 OPT-VFS	Voltaggio/frequenza speciali (115V / 60Hz) <i>Special voltage/frequency (115V / 60hz)</i>	Tutte le vetrine <i>All units</i>	-
 OPT-ABK	All black	Tutte le vetrine <i>All units</i>	-
 OPT-PCN	Porte colore Nero <i>Black doors</i>	Tutte le vetrine <i>All units</i>	-
 OPT-RIS	Rivestimento specchio <i>Mirror panel</i>	Tutte le vetrine M / C <i>All M / C units</i>	Moduli B Vetrine H <i>H units</i>
 OPT-FCA	Filtro a carboni attivi <i>Activated carbon filter</i>	Tutte le vetrine <i>All units</i>	Moduli B
Model Reg. n. TO 20 2016 0000 92512  OPT-V1	Vaschetta acciaio inox <i>Stainless steel tray</i>	Tutte le vetrine <i>All units</i>	-

<p>Controllabile da remoto tramite App dedicata. Consente l'assistenza e supporto da remoto. Permette l'ottenimento dei benefici fiscali previsti dal piano Transizione 4.0.</p>	<p><i>Remote control with dedicated app. Allows remote support and assistance.</i></p>
<p>Installazione impianto led RGB (60 led/m - 14,4 Wm - 24 V) in sostituzione dei led bianchi standard. Gestione tramite app Expo Connex collegandosi in wi-fi sul proprio router. Il colore bianco dei led RGB è bianco freddo (6.000-6.500 K). *Utilizzabile solo in abbinamento ad OPT-TCR.</p>	<p><i>Replaces standard white LEDs with RGB LEDs (30 led/m - 7,2 Wm - 550 lumen/m - 12 V). Manage with Expo Connex app by connecting through wi-fi router. White hue on RGB LEDs is cold white (6000-6500°K). *Only available if paired with OPT-TCR.</i></p>
<p>Installazione impianto led BIANCO DINAMICO (140 led/m - 19,2 Wm - 2.000 lumen/m - 24 V) in sostituzione dei led bianchi standard. Gestione tramite app Expo Connex collegandosi in wi-fi sul proprio router (variabile da bianco caldo 2700 K a bianco freddo 6000 K). Controllo intensità luminosa. *Utilizzabile solo in abbinamento ad OPT-TCR.</p>	<p><i>Replaces standard white LEDs with DYNAMIC WHITE LED system (140 led/m - 19,2 Wm - 2.000 lumen/m - 24 V). Manage with Expo Connex app by connecting through wi-fi router (adjustable from warm white 2700°K to cold white 6000°K). Includes dimmer setting. *Only available if paired with OPT-TCR.</i></p>
<p>Installazione impianto led RGB (30 led/m - 7,2 Wm - 550 lumen/m - 12 V) in sostituzione dei led bianchi standard. Telecomando per gestione colori, programmazione effetti ed intensità luminosa. Il colore bianco dei led RGB è bianco freddo (6.000-6.500 K).</p>	<p><i>Replaces standard white LEDs with RGB LEDs. Various colours, lighting effects and dimming can be selected with the included remote control. RGB's white hue is very cool (6000-6500°K). We suggest not using the RGB LEDs for cold dish and cured meats/cheese units.</i></p>
<p>Installazione impianto led BIANCO DINAMICO (140 led/m - 19,2 Wm - 2.000 lumen/m - 24 V) in sostituzione dei led bianchi standard. Telecomando per gestione colore bianco (variabile da bianco caldo 2700 K a bianco freddo 6000 K). Controllo intensità luminosa.</p>	<p><i>Installation of DYNAMIC WHITE (140 led/m - 19,2 Wm - 2.000 lumen/m - 24 V) setup in place of standard white LEDs. Remote control for white setting (ranging from warm white 2700 K to cold white 6000 K). Dimmer.</i></p>
<p>Installazione di Impianto frigorifero e parti elettriche accessorie con voltaggio frequenza speciali. Le versioni disponibili sono: 115 V - 60 Hz. Le vetrine a voltaggio 115 V sono state testate in base alla normativa UL per cui possono essere fornite con marchio ETL.</p>	<p><i>Installation of cooling system and added electrical parts with special voltage and frequency. Available setups are: 115 V - 60 Hz. Cabinets with 115 V systems have been tested in compliance to UL standards and therefore can be supplied with ETL mark.</i></p>
<p>Verniciatura a polveri epossidiche colore nero opaco di tutte le parti metalliche interne (montanti, pannelli interni, accessori, piano) ed esterne (profili porte, telai, maniglie, carter). A seconda dei modelli, alcuni particolari tipo viti o reggimensole vengono mantenuti in finitura inox.</p>	<p><i>Black matte epoxy powder coating of all internal (beams, internal panels, accessories, shelf) and external (door profiles, frame, handles, flank) metal parts. Depending on model, some details i.e. screw caps or shelf supports remain in stainless steel finish.</i></p>
<p>Verniciatura a polveri epossidiche colore Nero della parte esterna. MOD (profili porte, telaio di battuta delle porte, maniglie) TECA (profili porte maniglie).</p>	<p><i>Black epoxy powder coating of the external part. MOD (door profile, frame, handles) TECA (door profile, handle).</i></p>
<p>Sostituzione del rivestimento interno standard in alluminio anodizzato con un rivestimento in alluminio specchio. A secondo dei modelli, si può inserire il rivestimento a specchio nelle spalle laterali e nella schiena.</p>	<p><i>Replaces the standard anodized aluminium lining with an aluminium mirror coating. Depending on the model, it applies to side and back panels.</i></p>
<p>Filtro a carboni attivi ricaricabile. È possibile estrarre il filtro dalla vetrina e sostituire i carboni in pochi minuti. Permette un naturale ricircolo di aria nelle vetrine vino. È consigliato per le vetrine utilizzate per conservazione che non vengono aperte spesso.</p>	<p><i>Rechargeable activated carbon filter. The filter can be easily removed from the cabinet to quickly replace the coals. It allows a natural circulation of air in the wine showcase. This option is suggested for the showcases used for conservation that are not frequently opened.</i></p>
<p>Vaschetta in acciaio inox lucido con bordi piegati a 45 gradi, dim. L x P x H mm 171 x 195 x 15. È possibile posizionare 4 vaschette sia sul piano in vetro da mm 350 x 400 (cioccolato - gastronomia) che sul piano mm 340 x 400 (salumeria). Consente di ottimizzare lo spazio sul piano in tutte le vetrine cioccolato, gastronomia e salumeria.</p>	<p><i>Polished stainless steel tray with edges bent at 45 degrees, dim. W x D x H 171 x 195 x 15 mm. Up to 4 trays fit on each glass shelf 350 x 400 mm (chocolate - cold dishes) as well as on 340 x 400 mm shelves (cured meats/cheese). Useful to make the most of the available space for chocolate, cold dish and cured meats/cheese units.</i></p>

Optional

	CODE	CODE 		
OPTIONAL MOD - TECA *14 - 24 (M / C)				
	OPT-14MP-BF	OPT-14MP-BF-NR	Bottiglie frontali (Mod)	Front neck bottles (Mod)
	OPT-14T-BF	OPT-14T-BF-NR	Bottiglie frontali (Teca)	Front neck bottles (Teca)
	OPT-14MP-BF-3	OPT-14MP-BF-3-NR	Bottiglie frontali (Mod)	Front neck bottles (Mod)
	OPT-14T-BF-3	OPT-14T-BF-3-NR	Bottiglie frontali (Teca)	Front neck bottles (Teca)
	OPT-14MP-BI	OPT-14MP-BI-NR	Bottiglie inclinate (Mod)	Reclined bottles (Mod)
	OPT-14T-BI	OPT-14T-BI-NR	Bottiglie inclinate (Teca)	Reclined bottles (Teca)
	OPT-14-BO	OPT-14-BO-NR	Bottiglie orizzontali (Mod - Teca)	Horizontal bottles (Mod - Teca)
	OPT-14MP-PR	OPT-14MP-PR-NR	Piano regolabile (Mod)	Adjustable shelf (Mod)
	OPT-14T-PR	OPT-14T-PR-NR	Piano regolabile (Teca)	Adjustable shelf (Teca)
OPTIONAL MOD - TECA *14 - 24 (H)				
	OPT-14MPH-BI	OPT-14MPH-BI-NR	Bottiglie inclinate (Mod)	Reclined bottles (Mod)
	OPT-14TH-BI	OPT-14TH-BI-NR	Bottiglie inclinate (Teca)	Reclined bottles (Teca)
	OPT-14MPH-BI-3	OPT-14MPH-BI-3-NR	Bottiglie inclinate (Mod)	Reclined bottles (Mod)
	OPT-14TH-BI-3	OPT-14TH-BI-3-NR	Bottiglie inclinate (Teca)	Reclined bottles (Teca)
	OPT-14H-BO	OPT-14H-BO-NR	Bottiglie orizzontali (Mod - Teca)	Horizontal bottles (Mod - Teca)
	OPT-14MPH-PR	OPT-14MPH-PR-NR	Piano regolabile (Mod)	Adjustable shelf (Mod)
	OPT-14TH-PR	OPT-14TH-PR-NR	Piano regolabile (Teca)	Adjustable shelf (Teca)
OPTIONAL MOD - TECA *14 - 24 - KIT STANDARD				
	OPT-14MPH-KC	OPT-14MPH-KC-NR	Kit standard (Mod H)	Kit standard (Mod H)
	OPT-14MP-KC	OPT-14MP-KC-NR	Kit standard (Mod)	Kit standard (Mod)
	OPT-14TH-KC	OPT-14TH-KC-NR	Kit standard (Teca H)	Kit standard (Teca H)
	OPT-14T-KC	OPT-14T-KC-NR	Kit standard (Teca)	Kit standard (Teca)

Le vetrine *14 - 24 della serie Teca e Mod vengono fornite senza allestimenti.
È possibile personalizzare l'allestimento interno scegliendo uno o più optional tra quelli sopra indicati.

Piano in plexiglas con staffette di fissaggio. Il sistema è regolabile in altezza con passo di 5 cm in funzione delle bottiglie inserite. Ogni piano può contenere 4 bottiglie. Diametro massimo bottiglie 85 mm, altezza massima 360 mm.	<i>Plexiglas shelf with fixing brackets. The system is adjustable in height, shelves can be fitted every 5 cm. depending on how many and what kind of bottles you want to insert. Each shelf can hold 4 bottles.</i>
Piano in plexiglas con staffette di fissaggio. Il sistema è regolabile in altezza con passo di 5 cm in funzione delle bottiglie inserite. Ogni piano può contenere 3 bottiglie Magnum. Diametro massimo bottiglie 120 mm, altezza massima 400 mm.	<i>Perspex shelf with mounting brackets. The system is adjustable in height, shelves can be fitted every 5 cm. depending on how many and what kind of bottles you want to insert. Each shelf can hold 3 Magnum bottles.</i>
Struttura realizzata con laterali in plexiglas e tondini in alluminio. Questa struttura può essere posizionata a diverse altezze con interasse minimo di 20 cm. Può contenere fino 7 bottiglie classiche da 0.75 l oppure 4 Magnum ø 110 mm. Possibilità di installare 8 display (14) e 3 display (24) per ciascun vano. Diametro massimo bottiglie 95 mm, altezza massima 350 mm.	<i>Structure made of Plexiglas sides and aluminium rods. This structure can be positioned at different heights, with a minimum gap of 20 cm. It can hold 7 standard 0.75 l. bottles or 4 Magnum ø 110 mm. Up to 8 displays (14) and 3 displays (24) can be installed in each compartment.</i>
3 Kit composti da 8 tondini cadauno (totale 24 tondini). Con ogni kit è possibile esporre 3 file da 8 bottiglie (24 bottiglie totali) ed è regolabile in altezza ogni 10 cm. Diametro massimo bottiglie 90 mm, altezza massima 320 mm (Teca) 360 mm (Mod).	<i>3 kits made of 8 rods each (24 rods in total). Each kit stores 3 rows of 8 bottles (24 bottles total) and can be adjusted every 10cm in height.</i>
Piano regolabile in vetro temperato con reggi mensole. Il piano è regolabile con passo 5 cm. È molto utile per il posizionamento di bottiglie in verticale, bottiglie e decanter.	<i>The shelves can be positioned every 5 cm. Suitable for vertical bottles, glasses and decanters.</i>
Piano in plexiglass termoformato. Questo accessorio può essere posizionato a diverse altezze e può contenere 4 bottiglie classiche da 0,75 l. Possibilità di installare 5 display (14) e 3 display (24) per ciascun vano. Diametro massimo bottiglie 80 mm, altezza massima 350 mm.	<i>Thermoformed plexiglass support. This component can be positioned at different heights and can contain 4 classic 0.75 l bottles. Up to 5 displays (14) and 3 displays (24) can be installed in each compartment.</i>
Piano in plexiglass termoformato. Questo accessorio può essere posizionato a diverse altezze e può contenere 3 bottiglie da 0.75 cl. Diametro massimo bottiglie 100 mm, altezza massima 350 mm.	<i>Thermoformed plexiglass ledge. This component can be positioned at different heights and can contain 3 0.75 l bottles.</i>
4 Kit composti da 4 tondini cadauno (totale 16 tondini). Con un kit è possibile esporre 4 file da 4 bottiglie (16 bottiglie totali) ed è regolabile in altezza ogni 10 cm. Diametro massimo bottiglie 90 mm, altezza massima 320 mm (Teca) 360 mm (Mod).	<i>4 kits made of 4 rods each (16 rods in total). Each kit stores 4 rows of 4 bottles (16 bottles total) and can be adjusted every 10 cm in height.</i>
Piano regolabile in vetro temperato con reggi mensole. Il piano è regolabile con passo 5 cm. È molto utile per il posizionamento di bottiglie in verticale e bicchieri.	<i>The shelves can be positioned every 5 cm. Suitable for vertical bottles, glasses and decanters.</i>
Kit standard allestimento interno vetrine Mod H. Comprende n. 2 OPT-14MPH-BI - n. 1 OPT-14H-BO - n. 3 OPT-14MPH-PR	<i>Standard interior setup for Mod H cabinets. Includes n. 2 OPT-14MPH-BI - n. 1 OPT-14H-BO - n. 3 OPT-14MPH-PR</i>
Kit standard allestimento interno vetrine Mod. Comprende n. 5 OPT-14MP-BF n. 3 OPT-14MP-BI - n. 2 OPT-14MP-PR - n. 1 OPT-14-BO	<i>Standard interior setup for Mod cabinets. Includes n. 5 OPT-14MP-BF - n. 3 OPT-14MP-BI - n. 2 OPT-14MP-PR - n. 1 OPT-14-BO</i>
Kit standard allestimento interno vetrine Teca H. Comprende n. 2 OPT-14TH-BI - n. 1 OPT-14H-BO - n. 3 OPT-14TH-PR	<i>Standard interior setup for Teca H cabinets. Includes n. 2 OPT-14TH-BI - n. 1 OPT-14H-BO - n. 3 OPT-14TH-PR</i>
Kit standard allestimento interno vetrine Teca. Comprende n. 5 OPT-14T-BF n. 3 OPT-14T-BI - n. 2 OPT-14T-PR - n. 1 OPT-14-BO	<i>Standard interior setup for Teca cabinets. Includes n. 5 OPT-14T-BF - n. 3 OPT-14T-BI - n. 2 OPT-14T-PR - n. 1 OPT-14-BO</i>

*The units * 14 - 24 of the Teca and Mod series are supplied without internal fittings. You can customize the interior by choosing one or more of the options above.*



CENTRAL COOLING SYSTEM (PATENTED)

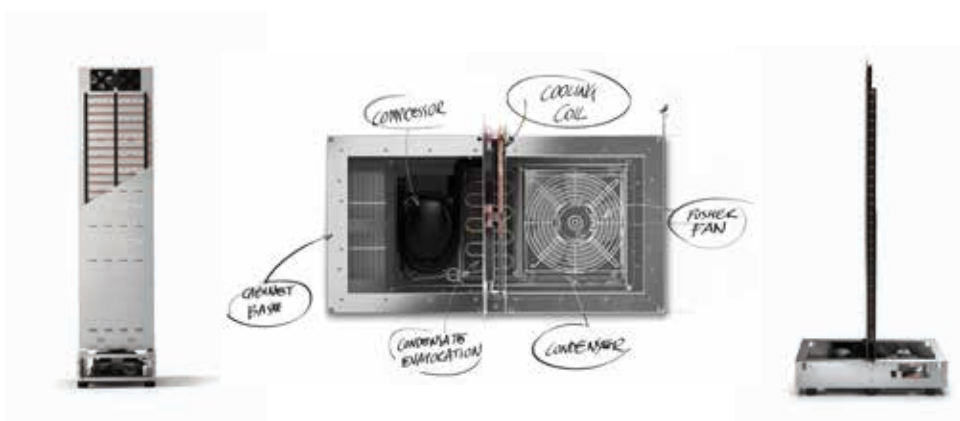

Rappresenta una rivoluzione nel campo della termodinamica applicata. È il primo frigorifero al mondo con serpentina di evaporazione al centro del vano refrigerato, un perfetto equilibrio termico.

L'evaporatore diventa un supporto. Tutte le bottiglie sono poste alla stessa distanza dalla fonte del freddo.

Si tratta di un'intuizione che ha aperto la strada ad una nuova concezione di progettazione e costruzione, capace di valorizzare nuovi volumi e creare inattese trasparenze.

A revolution in applied thermodynamics.

The first refrigerator in the world with an evaporation coil in the middle of the refrigerated compartment, a perfect thermal balance.

The evaporator becomes a support. All bottles are at the same distance from the source of cold.

An insight that paved the way to a new concept in design and construction, adding value to new volumes and creating unexpected transparencies.

UNITÀ REFRIGERANTE INTEGRATA (STANDARD)

IMPIANTO A REFRIGERAZIONE CENTRALE (brevettato) - CONDENSAZIONE VENTILATA

Installato su tutte le vetrine profondità (510 - 530 mm)

CENTRAL COOLING SYSTEM (patented) • Installed on all cabinets with (510 - 530 mm) depth

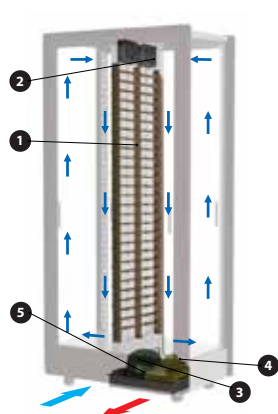

STANDARD

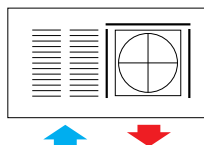

OPTIONAL OPT-EAP

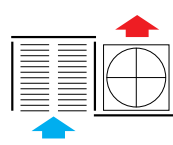

OPTIONAL OPT-PUR



circolazione aria interna inside air flow	aspirazione aria ambiente cold air intake	espulsione aria calda warm air exhaust

La serpentina di raffreddamento ① e le ventole di aereazione interna ② sono inserite al centro della vetrina all'interno dei pannelli di alluminio. Il compressore ③, il condensatore orizzontale con ventola a pala premente ④ e la vasca per l'evaporazione della condensa ⑤ sono inseriti in una speciale vasca ribassata. Con questa soluzione, pur installando un compressore importante (1/4 hp), l'altezza della base è limitata (150 mm) in quanto viene utilizzato lo spazio inferiore dove sono inseriti i piedi (40 mm). La circolazione dell'aria di condensazione avviene dalla parte inferiore frontale.

The cooling coil ① and the internal fans ② are installed in the middle of the cabinet inside the aluminium panels. The compressor ③, the horizontal condensing unit, the pushing fan ④ and the vat for the evaporation of the condensation water ⑤ are placed in a special lowered tank. With this solution, despite installing an high power compressor (1/4 hp), the height of the base is limited (150 mm) as it takes up the lower space where feet are located (40 mm).

Condensation air circulates from the bottom front part.

Espulsione aria posteriore • Air exhaust at rear

CODE



OPT-EAP

Inserimento di deflettori che convogliano l'aria calda nel lato posteriore.

UNITÀ REFRIGERANTE REMOTA

Predisposizione unità remota • Setting for remote compressor



OPT-PUR

Le vetrine sono sprovviste di unità condensatrice. Tutte le vetrine vengono predisposte con valvola termostatica di serie. Le tubazioni per l'allacciamento alla linea frigorifera sono nella parte inferiore della vetrina. È necessario prevedere una linea di scarico per l'acqua di condensa e l'alimentazione elettrica. Valvole Danfoss con orificio potenza 0.0. La valvola termostatica è posizionata all'interno del vano tecnico a cui è possibile accedere dall'interno della vetrina

CODE	<table border="1"><tr><td>A</td><td>B</td></tr><tr><td>D</td><td></td></tr></table>	A	B	D		<table border="1"><tr><td>AH</td></tr><tr><td>DH</td></tr></table>	AH	DH	mm LxPxH	
A	B									
D										
AH										
DH										
GAS R134a / R513a										
OPT-UCE-01A-134	A	AH	480 x 300 x 275	EMBRACO NEK6187Z						
OPT-UCE-02A-134	AA	AAH / AAAH	540 x 300 x 275	EMBRACO NT6215Z						
OPT-UCE-03A-134	AAA	-	540 x 390 x 350	EMBRACO NJ6226Z						
OPT-UCE-01D-134	D	DH / DDH	480 x 300 x 275	EMBRACO EMT6160Z						
OPT-UCE-02D-134	DD	DDDH	510 x 300 x 275	EMBRACO NEU6214Z						
OPT-UCE-03D-134	DDD	-	540 x 390 x 350	EMBRACO NJ6220Z						
OPT-UCE-01B-134	B	-	460 x 300 x 275	EMBRACO EMT6144Z						
GAS R452/404										
OPT-UCE-01A-404	A	-	480 x 300 x 275	EMBRACO EMT6165GK						
OPT-UCE-02A-404	AA	-	510 x 330 x 295	EMBRACO NEK6213GK						
OPT-UCE-03A-404	AAA	-	540 x 390 x 350	EMBRACO NT6226GK						
OPT-UCE-01D-404	D	-	480 x 300 x 275	EMBRACO EMT6152GK						
OPT-UCE-02D-404	DD	-	510 x 300 x 275	EMBRACO NEK6210GK						
OPT-UCE-03D-404	DDD	-	510 x 390 x 350	EMBRACO NEK6217GK						

Le potenze sono state calcolate per una linea frigorifera non superiore a 15 metri • Compressor power is calculated considering a distance not higher than 15 meters

IMPIANTO A REFRIGERAZIONE POSTERIORE - CONDENSAZIONE STATICA

Installato su tutte le vetrine profondità (350 - 362 mm)

REAR COOLING SYSTEM - static condensation · Installed on all cabinets with (350 - 362 mm) depth

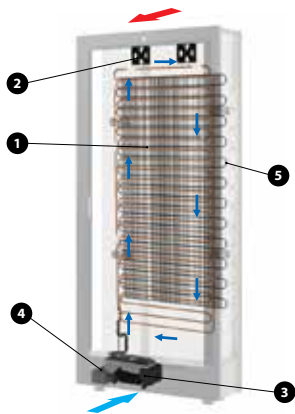

circolazione aria interna inside air flow	aspirazione aria ambiente cold air intake	espulsione aria calda warm air exhaust

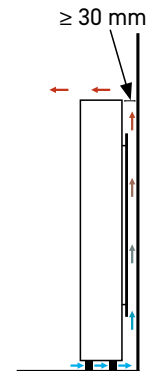

La serpentina di raffreddamento **1** e le ventole di aereazione interna **2** sono posizionate all'interno del vano refrigerato dietro il pannello posteriore in alluminio. Il compressore ad inverter **3** e la vasca per l'evaporazione della condensa **4** sono inseriti nella base inferiore. Il condensatore statico **5** è installato nel retro della vetrina. Il raffreddamento del condensatore avviene per convezione senza l'ausilio di ventole. L'aria ambiente passa sotto la base e sale nello spazio tra il retro della vetrina ed il muro, si scalda ed esce dall'alto.

The cooling coil **1** and the internal aeration fans **2** are placed inside the refrigerated compartment, behind the aluminum back panel. The inverter compressor **3** and the evaporation pan **4** are placed in the lower base. The static condenser **5** is installed in the back of the cabinet. The condenser cools down due to convection without the use of fans. Ambient air comes through under the base and rises in the gap between the back of the cabinet and the wall, gets warm and exits from the top.

Insertion of deflectors which send the hot air to the back.

The units are provided without condensing unit. They are supplied with thermostatic valve as standard. The pipes for the connection to the refrigerating line are in the lower part of the unit. It is necessary to provide a discharge pipe for the condensing water and the power supply. Danfoss valves with 0.0 power orifice. The thermostatic valve is located inside the technical compartment, which can be accessed from inside the cabinet.

HP	HF	mm			* - 10 °C	mm L A
1/3	R134a	230	230 / 1 / 50	488	500	6 - 10
5/8	R134a	230	230 / 1 / 50	884	854	10 - 12
1	R134a	300	230 / 1 / 50	1477	1508	10 - 16
1/4 L	R134a	230	230 / 1 / 50	337	390	6 - 10
1/2	R134a	230	230 / 1 / 50	734	760	6 - 10
3/4	R134a	300	230 / 1 / 50	1093	1054	10 - 12
1/5	R134a	230	230 / 1 / 50	235	315	6 - 10
1/4 L	R452/404	230	230 / 1 / 50	560	512	6 - 10
1/2	R452/404	254	230 / 1 / 50	1080	964	6 - 10
1	R452/404	300	230 / 1 / 50	2020	1688	10 - 16
1/5	R452/404	230	230 / 1 / 50	430	430	6 - 10
1/3	R452/404	230	230 / 1 / 50	770	733	6 - 10
5/8	R452/404	300	230 / 1 / 50	1198	1162	10 - 12

EXPO CONNEX

Expo ConneX è un'applicazione per il monitoraggio ed il controllo wireless dei prodotti Della Marta.

L'app permette all'utente di usufruire dei servizi di report settimanale e di alert tramite messaggi push e via mail. È possibile controllare e modificare, anche a distanza ed in tempo reale, le temperature e le impostazioni delle vetrine. Grazie a questo sistema di connessione sempre attivo, la vetrina viene monitorata e consente di ricevere supporto tecnico, tramite diagnostica, in qualsiasi parte del mondo il prodotto si trovi.

L'applicazione Expo ConneX è disponibile su Play Store e App Store.

Expo ConneX is an app for wireless remote monitoring and control of Della Marta products.

This app allows the user to view weekly reports and receive push and email alerts. It allows to control and edit, remotely and in real time, temperature and settings of the cabinets. Thanks to this always-running connection system, the cabinet is monitored and remote technical support – through diagnostics – can be provided anywhere in the world.

Expo ConneX is available on the App Store and Play Store.



FILTRO A CARBONI ATTIVI



Cambiare spesso i carboni è importante per mantenere un corretto microclima all'interno della vetrina.
Il filtro a carboni attivi ricaricabile consente la facile sostituzione dei carboni senza dover necessariamente sostituire l'intero filtro.
I carboncini esausti possono essere conferiti nell'organico.
Una soluzione nel segno della massima sostenibilità ambientale.

*Changing carbons often is important to maintain an appropriate microclimate inside the cabinet.
Rechargeable activated carbon filter lets you easily swap carbons without necessarily changing the whole filter.
Exhausted carbons can be disposed of as organic waste.
A solution in the name of maximum environmental sustainability.*

Emme 12

CARATTERISTICHE TECNICHE

Specifications

Struttura in metallo
Struttura porta in alluminio
Cornice in legno / hpl / MDF
Vetrocamera 20 mm / Guarnizione magnetica
Pannello interno in acciaio
Illuminazione a LED bianco caldo
(3000 K - 160 led/mt - 14,4 W / mt - 1585 lumen / mt - 24 v)
Refrigerazione statica e ventilata
Termoregolatore digitale
Sbrinamento automatico
Sistema antivibrazione
Filtro a carboni attivi ricaricabile
Compressore ad inverter
Gestione tramite app Expo Connex

*Metal structure
Aluminum door structure
Wood / HPL / MDF door frame
20 mm double glazing / Magnetic gasket
Internal steel panel
Cold white daylight LED
(3000 K - 160 led/mt - 14,4 W / mt - 1585 lumen / mt - 24 v)
Static and ventilated refrigeration
Digital temperature controller
Automatic defrosting
Anti-vibration system
Rechargeable active carbon filter
Inverter compressor
Manage with Expo Connex app*

I modelli E-M12 e E-M12G devono essere fissati alla parete utilizzando le staffe in dotazione.

The E-M12, E-M12G models must be fixed to the wall with the provided brackets.

EXPO CONNEX

di serie • *standard*

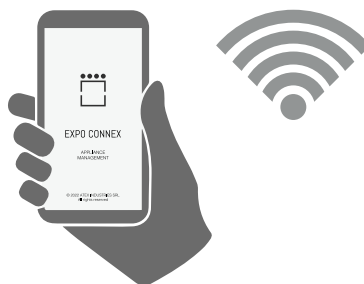

Expo ConneX è un'applicazione per il monitoraggio ed il controllo wireless dei prodotti Della Marta.

L'app permette all'utente di usufruire dei servizi di report settimanale e di alert tramite messaggi push e via mail. È possibile controllare e modificare, anche a distanza ed in tempo reale, le temperature e le impostazioni delle vetrine. Grazie a questo sistema di connessione sempre attivo, la vetrina viene monitorata e consente di ricevere supporto tecnico, tramite diagnostica, in qualsiasi parte del mondo il prodotto si trovi.

L'applicazione Expo Connex è disponibile su Play Store e App Store.

Expo ConneX is an app for wireless remote monitoring and control of Della Marta products.

This app allows the user to view weekly reports and receive push and email alerts. It allows to control and edit, remotely and in real time, temperature and settings of the cabinets. Thanks to this always-running connection system, the cabinet is monitored and remote technical support – through diagnostics – can be provided anywhere in the world.

Expo ConneX is available on the App Store and Play Store.



OPTIONAL DISPONIBILI SU TUTTI I MODELLI

Options available on all models

(Pag. 126)

OPT-RGB-CX · OPT-CBD-CX



EM-12



EM-12G

1 - CORNICI • *Frames*

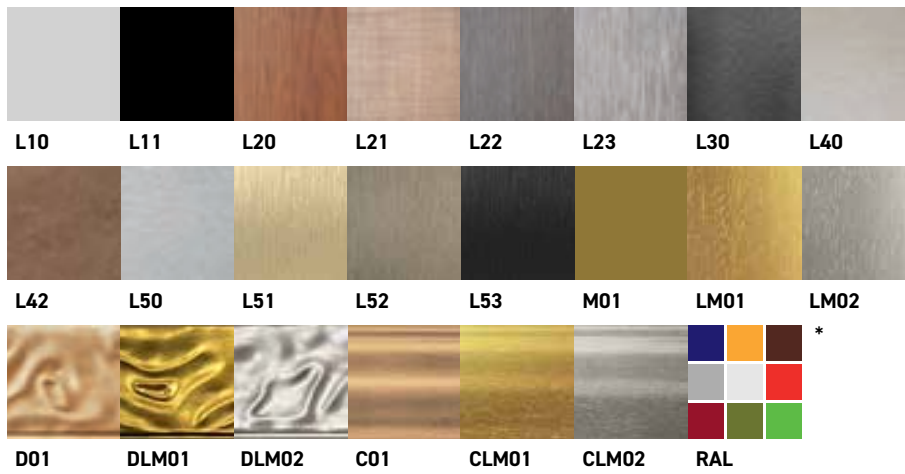



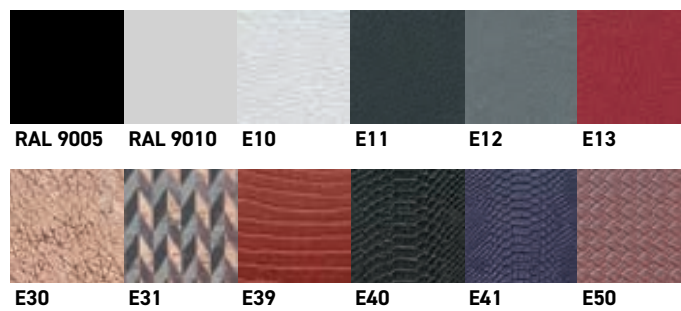







2 - PANNELLI • *Panels*



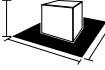

* I colori RAL vengono realizzati su supporto di MDF in finitura opaca 20 gloss. - * RAL colours are made on MDF 20-gloss matte finish.





Emme 12

CODE	 mm LxPxH	 N. 0,75 LT		Class	 Pnom 	 KWh annum	 HF
	 mm LxPxH	 H Ø					 HF

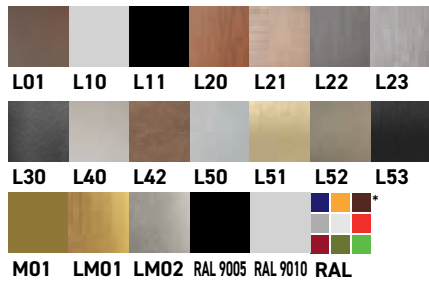

STRUTTURA • STRUCTURE

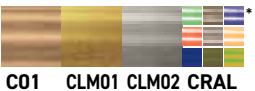
	EM-12	650 x 273 x 1696	12	60	SN-N	44 W	-	R 600 a
		1000 x 800 x 1900	H 324 Ø 105		230 50-60Hz			40
	EM-12G	650 x 273 x 1696	8	40	SN-N	44 W	-	R 600 a
		1000 x 800 x 1900	H 324 Ø 105		230 50-60Hz			40

CORNICE • FRAMES



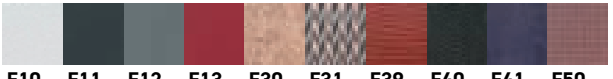



CODE	 L01 L10 L11 L20 L21 L22 L23 L30 L40 L42 L50 L51 L52 L53 M01 LM01 LM02 RAL 9005 RAL 9010 RAL	 D01 DLM01 DLM02 DRAL 9005 DRAL 9010 DRAL	 C01 CLM01 CLM02 CRAL	
		E-M12-C	.	.











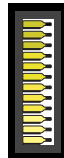

PANNELLO • PANELS







CODE	 RAL 9010 RAL 9005	 E10 E11 E12 E13 E30 E31 E39 E40 E41 E50	
	E-M12-P	.	.
	E-M12G-P	.	.





* I colori RAL vengono realizzati su supporto di MDF in finitura opaca 20 gloss.





* RAL colours are made in MDF 20-gloss matte finish.

		 		 OFF	 ON
--	---	--	---	--	---

NW	35	86	1,5				
		111		SET 6 °C 	SET 14 °C 	SET 6 °C 	SET 14 °C 
							

NW	35	86	1,5		
		111		SET 6 °C 	SET 6 °C 
					

			
650 x 10 x 1668	3	40	0,35

			
600 x 1580 x 2	-	-	-
600 x 1580 x 2	-	-	-

Le temperature riportate sono indicative e possono variare di (+ -) 2 °C. Rilevazioni effettuate con temperatura ambiente di 25 °C.
 Reported temperatures are approximate and may vary by (+ -) 2 °C. Detections made in 25 °C ambient temperature.

Quadro Vino

CARATTERISTICHE TECNICHE

Specifications

Struttura in metallo
Struttura porta in alluminio
Cornice in legno / hpl / MDF
Vetrocamera 20 mm / Guarnizione magnetica
Pannello interno in acciaio
Illuminazione a LED bianco naturale
(4000 K - 60 led/mt - 4,8 W / mt - 416 lumen / mt dimmerabile - 12 V)
Sbrinamento automatico
Refrigerazione ventilata
Sistema di antivibrazione

*Metal structure
Aluminum door structure
Wood / HPL / MDF door frame
20 mm double glazing / Magnetic gasket
Internal steel panel
White natural daylight LED
(4000 K - 60 led/mt - 4,8 W / mt - 416 lumen / mt dimmer - 12 V)
Automatic defrosting
Ventilated refrigeration
Anti-vibration system*

CONFIGURATORE ONLINE

Online builder



THERMOELECTRIC COOLING SYSTEM

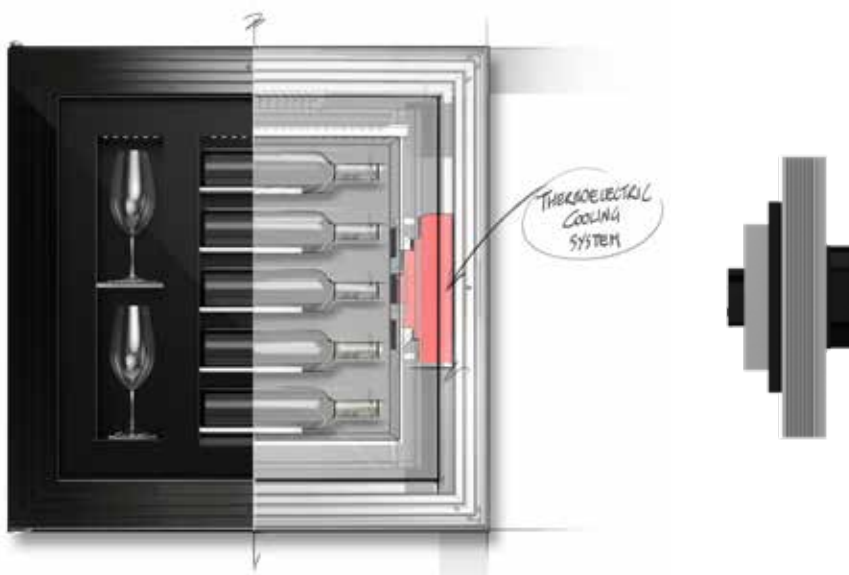

Disegnato ed ingegnerizzato per la specifica applicazione sul Quadro Vino, è pura tecnologia del freddo in miniatura. Il sistema utilizzato è termoelettrico. L'impianto è ecologico, privo di gas inquinanti e costruito con materiali completamente riciclabili.

Designed and engineered specifically for application on Quadro Vino, it is concentrated miniature cold technology. It employs a thermoelectrical system. It is a green system, free of polluting gases and built with entirely recyclable materials.

MODELLO • Model

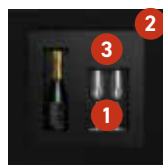

QV12



QV30

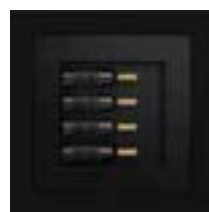

QV40



QV52

1 - STRUTTURA • Structure



Standard
RAL 9005
nero
black

N



Optional
RAL 9010
bianco
white

B

2 - CORNICI • Frames

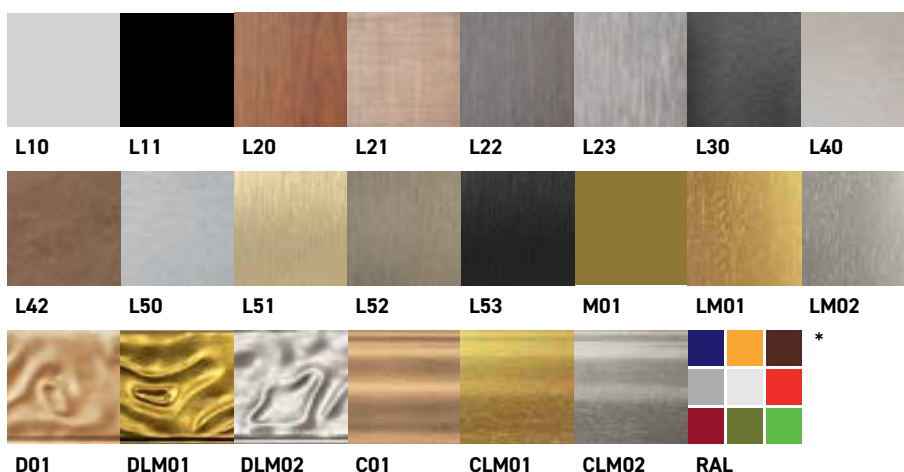

3 - PANNELLI • Panels













COLORE LUCE • Light colour

○○○ Standard: LED bianco naturale • white natural daylight LED





●●● Optional: LED blu • blue LED (OPT-QLB)

* I colori RAL vengono realizzati su supporto di MDF in finitura opaca 20 gloss. - * RAL colours are made on MDF 20-gloss matte finish.





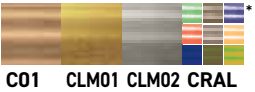

Quadro Vino

CODE	 mm LxPxH	 mm LxPxH	 mm LxPxH	N.  0,75 LT	H  Ø	 LT	Class
 QV12N	600 x 600 x 155	700 x 700 x 250	800 x 1000 x 390	1	H 324 Ø 105	3	SN-N
 QV30N	600 x 600 x 155	700 x 700 x 250	800 x 1000 x 390	3	H 328 Ø 98	11	SN-N
 QV40N	780 x 780 x 155	860 x 860 x 250	1000 x 1000 x 390	4	H 400 Ø 90	16	SN-N
 QV52N	780 x 780 x 155	860 x 860 x 250	1000 x 1000 x 390	5	H 328 Ø 90	15	SN-N

CORNICE • FRAMES

CODE	 L01 L10 L11 L20 L21 L22 L23 L30 L40 L42 L50 L51 L52 L53 M01 LMO1 LMO2 RAL 9005 RAL 9010 RAL	 Dune D01 DLM01 DLM02 DRAL 9005 DRAL 9010 DRAL	 Classica C01 CLM01 CLM02 CRAL
 QV1230C-	•	•	•
QV4052C-	•	•	•

PANNELLO • PANELS

CODE	 RAL 9010 RAL 9005	 E10 E11 E12 E13 E30 E31 E39 E40 E41 E50
 QV12P-	•	•
 QV30P-	•	•
 QV40P-	•	•
 QV52P-	•	•

* I colori RAL vengono realizzati su supporto di MDF in finitura opaca 20 gloss.

* RAL colours are made in MDF 20-gloss matte finish.

--	--	--	--	--	--	--	--	--	--	--	--	--	--

G	30	238	NW	29	100 - 240V	22	25	33	0,1	0,3	+4 / +6	+6 / +8	+8 / +10
G	60	194	NW	29	100 - 240V	22	25	33	0,1	0,3	+8 / +10	+10 / +12	+12 / +14
G	60	182	NW	29	100 - 240V	30	39	45	0,2	0,4	+12 / +14	+14 / +16	+16 / +18
G	60	198	NW	29	100 - 240V	30	39	45	0,2	0,4	+12 / +14	+14 / +16	+16 / +18

600 x 600 x 10	2	18	0,02
780 x 780 x 10	2,5	20	0,02

540 x 540 x 1,2	-	-	-
540 x 540 x 1,2	-	-	-
715 x 715 x 1,2	-	-	-
715 x 715 x 1,2	-	-	-

Le temperature riportate sono indicative e possono variare di (+ -) 2 °C. Rilevazioni effettuate con temperatura ambiente di 25 °C.
 Reported temperatures are approximate and may vary by (+ -) 2 °C. Detections made in 25 °C ambient temperature.

COLORS

HPL laminato alta pressione · High pressure laminate

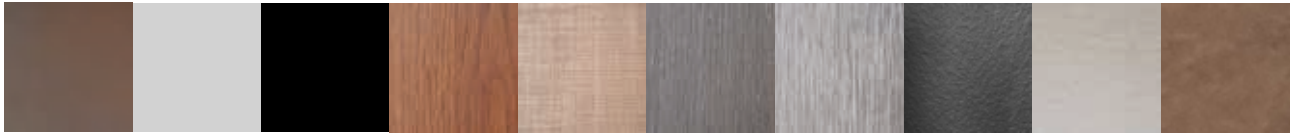

- L01**
HPL grezzo
raw HPL
- L10**
bianco opaco
matte white
- L11**
nero opaco
matte black
- L20**
castagno
chestnut
- L21**
Teak Roble
Teak Roble
- L22**
wengé loft
loft wenge
- L23**
larice cenere
ash larch
- L30**
nero materico
textured black
- L40**
cemento tortora
dove concrete
- L42**
corten
corten



- L50**
acciaio satinato
brushed steel
- L51**
oro satinato
satin gold
- L52**
bronzo satinato
satin bronze
- L53**
nero satinato
satin black

MDF Ayous Verniciatura a liquido · Liquid paint finish



- M01**
MDF non verniciato
no finish MDF
- A01**
ayous non verniciato
no finish ayous
- LM01**
oro metallico liquido
liquid metal gold
- LM02**
argento metallico liquido
liquid metal silver
- RAL 9010**
bianco opaco
matte white
- RAL 9005**
nero opaco
matte black
- RAL 20**
opaco 20 gloss
matte 20 gloss

Dune Verniciatura a liquido · Liquid paint finish



- D01**
Dune non verniciato
no finish Dune
- DLM01**
oro metallico liquido
liquid metal gold
- DLM02**
argento metallico liquido
liquid metal silver
- DRAL 9010**
bianco opaco (20 gloss)
matte white (20 gloss)
- DRAL 9005**
nero opaco (20 gloss)
matte black (20 gloss)
- DRAL 20**
opaco
matte

Classica Verniciatura a liquido · Liquid paint finish



- C01**
non verniciata
no finish Classic
- CLM01**
oro metallico liquido
liquid metal gold
- CLM02**
argento metallico liquido
liquid metal silver
- CRAL 9010**
bianco opaco (20 gloss)
matte white (20 gloss)
- CRAL 9005**
nero opaco (20 gloss)
matte black (20 gloss)
- CRAL 20**
opaco
matte

Ecopelle · Faux leather



- E10**
ecopelle bianca
white faux leather
- E11**
ecopelle nera
black faux leather
- E12**
ecopelle grigia
grey faux leather
- E13**
ecopelle rossa
red faux leather
- E39**
ecopelle pitone rosso
red python faux leather
- E40**
ecopelle rettile nera
black faux reptile leather
- E41**
ecopelle rettile blu
blue faux reptile leather
- E50**
ecopelle intrecciata tabacco
tobacco woven faux leather

Sughero · Cork

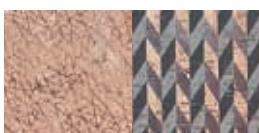

- E30**
sughero rete
cork mesh
- E31**
sughero spina di pesce
cork herringbone

Nobilitato

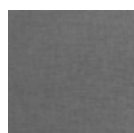

- N10**
grigio
grey



Colorazioni speciali RAL • *Special RAL colors*



RAL 1001 BEIGE	RAL 1002 SAND YELLOW	RAL 1003 SIGNAL YELLOW	RAL 1006 MAIZE YELLOW	RAL 1007 DAFFODIL YELLOW	RAL 1011 BROWN BEIGE	RAL 1014 IVORY	RAL 1015 LIGHT IVORY	RAL1019 GREY BEIGE	RAL 1024 OCHRE YELLOW
--------------------------	--------------------------------	----------------------------------	---------------------------------	------------------------------------	--------------------------------	--------------------------	--------------------------------	------------------------------	---------------------------------



RAL 1034 PASTEL YELLOW	RAL 2000 YELLOW ORANGE	RAL 2003 PASTEL ORANGE	RAL 2010 SIGNAL ORANGE	RAL 3004 PURPLE RED	RAL 3005 WINE RED	RAL 3007 BLACH RED	RAL 3009 OXIDE RED	RAL 3012 BEIGE RED	RAL 3017 ROSE
----------------------------------	----------------------------------	----------------------------------	----------------------------------	-------------------------------	-----------------------------	------------------------------	------------------------------	------------------------------	-------------------------



RAL 3031 ORIENT RED	RAL 4001 RED LILAC	RAL 4004 CLARET VIOLET	RAL 4009 PASTEL VIOLET	RAL 5003 SAPPHIRE BLUE	RAL 5004 BLACK BLUE	RAL 5005 SIGNAL BLUE	RAL 5008 GREY BLUE	RAL 5012 LIGHT BLUE	RAL 5014 PIGEON BLUE
-------------------------------	------------------------------	----------------------------------	----------------------------------	----------------------------------	-------------------------------	--------------------------------	------------------------------	-------------------------------	--------------------------------



RAL 5020 OCEAN BLUE	RAL 6005 MOSS GREEN	RAL 6011 RESEDA GREEN	RAL 6019 PASTEL GREEN	RAL 7000 SQUIRREL GREY	RAL 7001 SILVER GREY	RAL 7003 MOSS GREY	RAL 7004 SIGNAL GREY	RAL 7006 BEIGE GREY	RAL 7011 IRON GREY
-------------------------------	-------------------------------	---------------------------------	---------------------------------	----------------------------------	--------------------------------	------------------------------	--------------------------------	-------------------------------	------------------------------

















RAL 7030 STONE GREY	RAL 7032 PEBBLE GREY	RAL 7035 LIGHT GREY	RAL 7036 PLATINUM GREY	RAL 7042 TRAFFIC GREY A	RAL 8002 SIGNAL BROWN	RAL 8007 FAWN BROWN	RAL 8014 SEPIA BROWN	RAL 8017 CHOCOLATE BROWN	RAL 8019 GREY BROWN
-------------------------------	--------------------------------	-------------------------------	----------------------------------	-----------------------------------	---------------------------------	-------------------------------	--------------------------------	------------------------------------	-------------------------------















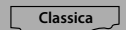





RAL 8022 BLACK BROWN	RAL 8025 PALE BROWN	RAL 8028 TERRA BROWN	RAL 9001 CREAM	RAL 9002 GREY WHITE	RAL 9003 SIGNAL WHITE	RAL 9004 SIGNAL BLACK	RAL 9005 JET BLACK	RAL 9010 PURE WHITE	RAL 9016 TRAFFIC WHITE
--------------------------------	-------------------------------	--------------------------------	--------------------------	-------------------------------	---------------------------------	---------------------------------	------------------------------	-------------------------------	----------------------------------

I colori stampati in questa cartella sono indicativi
The colours printed and shown in this folder are merely indicative

Legenda Legend

CODE	Codice	Code
	Temperatura (Temperatura interna vano refrigerato)	Temperature (Internal temperature in refrigerated compartment)
	Temperatura ambiente (Umidità relativa 50%)	Ambient temperature (Relative humidity 50%)
	Versione	Versio n
	Refrigerato	Cooled
	Neutro	Neutral
	Riscaldato	Heated
	Ventole interne spente	Internal fans off
	Ventole interne accese	Internal fans on
	Rumorosità - Pressione acustica Leq (h 155 cm - d. 100 cm)	Noise level - Leq sound pressure level (h 155 cm - d. 100 cm)
	Tensione	Voltage
	Assorbimento	Absorption
Class	Classe climatica	Climate class
	Modello/tipologia compressore	Compressor type
INV	Compressore inverter	Inverter compressor
FIX	Compressore a giri fissi	Fixed-speed compressor
HF	Gas refrigerante	Refrigerant gas
	Quantità gas	Gas amount
	Numero piastre eutettiche	Number of eutectic plates
	Luce	Light
NW	Led bianco naturale (4000 K - 60 led/mt - 4,8 W / mt - 416 lumen / mt - 12V)	White natural daylight LED (4000 K - 60 led/mt - 4,8 W / mt - 416 lumen / mt - 12V)
WW	Led bianco caldo (3000 K - 60 led/mt - 1,2 W / mt - 130 lumen / mt - 12V)	brightwhite warm LED (3000 K - 60 led/mt - 1,2 W / mt - 130 lumen / mt - 12V)
BL	Led blu	Blue LED
RGB	Controller RGB (60 led/mt - 14,4 W / mt - 24V)	RGB controller (60 led/mt - 14,4 W / mt - 24V)
CCT	Controller bianco dinamico (2700/6000 K - 140 led/mt - 19,2 W / mt - 2000 lumen / mt)	Dinamic white controller (2700/6000 K - 140 led/mt - 19,2 W / mt - 2000 lumen / mt)



	Cornice lineare	Linear frame
	Cornice Dune	Dune frame
	Cornice Classica	Classic frame
	Lato posteriore vetrina	Showcase back side
	Ante in vetro	Glass doors
	Pannello cieco	Blank panel
 0,75 LT	Numero bottiglie	Number of bottles
 H ∅	Altezza / diametro bottiglie	Bottle height / diameter
	Presente	Present
-	Assente / dato non disponibile	Absent / data not available
	Volume interno	Internal volume
 mm LxPxH	Dimensioni nette	Net dimensions
 mm LxPxH	Dimensioni con imballo	Dimensions including packaging
 mm LxPxH	Dimensioni con imballo su pedana	Dimensions including packing on pallet
 Kg	Peso netto	Net weight
 Kg	Peso con imballo	Weight with packaging
 Kg	Peso con imballo su pedana	Weight with packing on pallet
 m ³	Volume con imballo	Volume with packaging
 m ³	Volume con imballo su pedana	Volume with packaging on pallet
	Imballo in legno	Wooden packaging
DS	Descrizione	Description
 mm	Dimensione ventola	Fan blade size
 mm L A	∅ mm - Connessioni (liquido - aspirazione)	∅ mm - Connections (liquid - suction)



DELLA MARTA

Factory: Via G. Di Vittorio, 11 · 10098 Rivoli (TO) · ITALY

Flagship store: Via Pietro Maroncelli, 5 · 20154 Milano · ITALY

www.dellamarta.it · info@dellamarta.it

